

Introduction to Computer Graphics

GAMES101, Lingqi Yan, UC Santa Barbara

Lecture 8: Shading 2 (Shading, Pipeline and Texture Mapping)

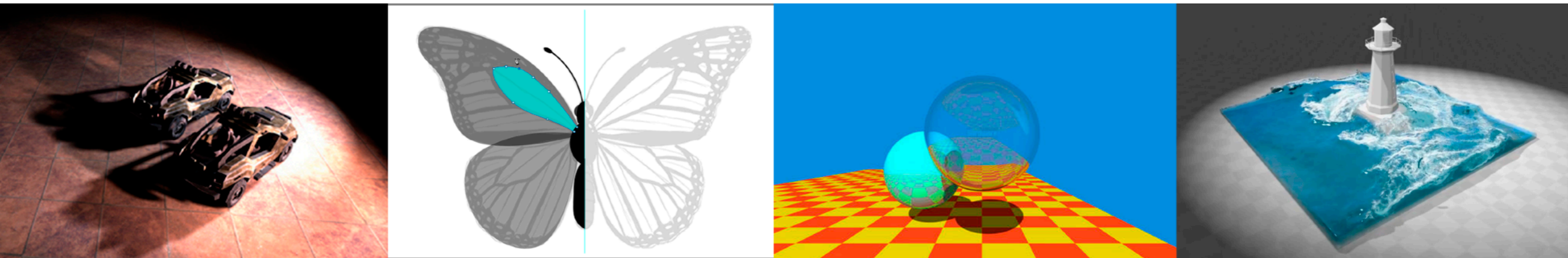

Announcements

- Homework 2
 - 45 submissions so far
 - Upside down? No problem
 - Active discussions in the BBS, pretty good
- Next homework is for shading
- Today's topics
 - Easy, but a lot

Last Lecture

- Shading 1
 - Blinn-Phong reflectance model
 - Diffuse
 - Specular
 - Ambient
 - At a **specific shading point**

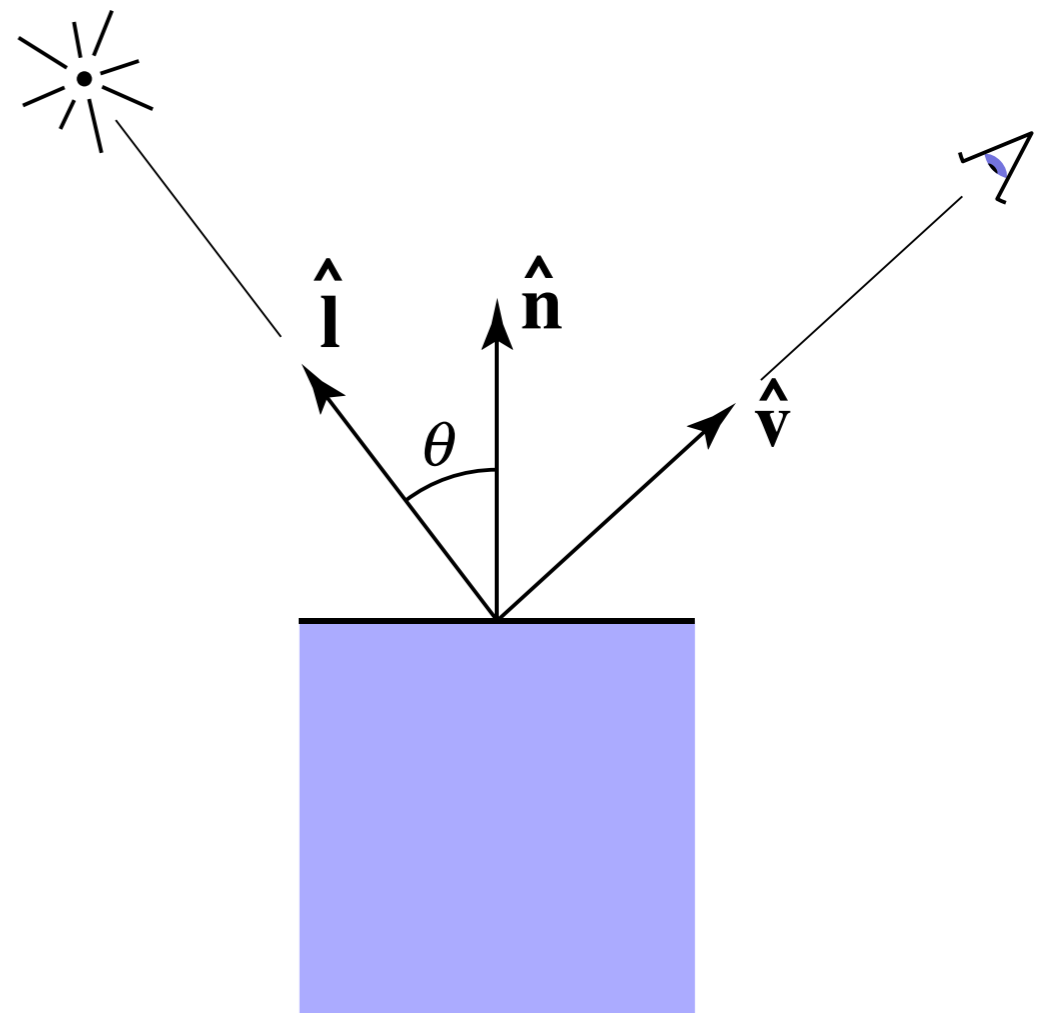

Today

- Shading 2
 - Blinn-Phong reflectance model
 - Specular and ambient terms
 - Shading frequencies
 - Graphics pipeline
 - Texture mapping
 - Barycentric coordinates

Recap: Lambertian (Diffuse) Term

Shading **independent** of view direction

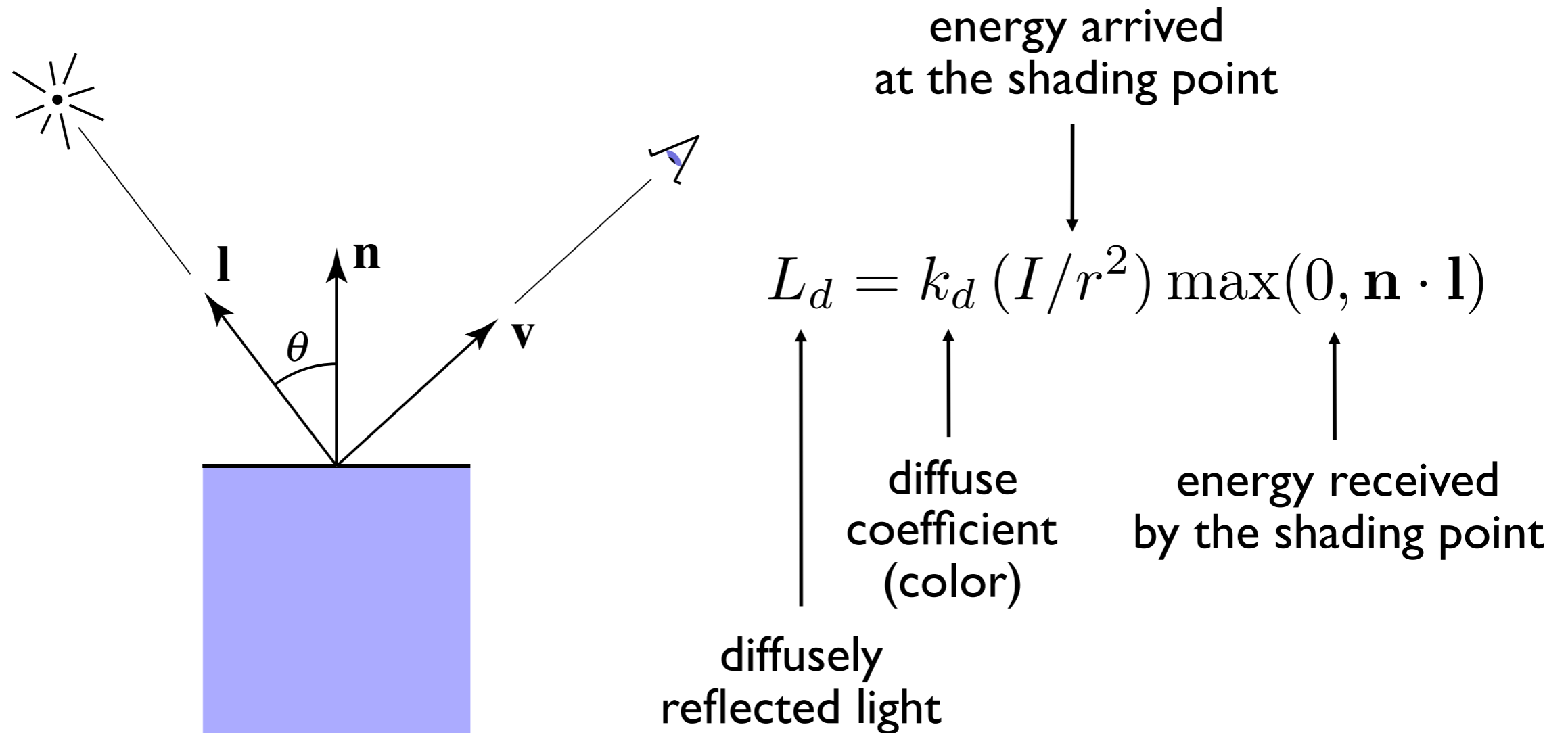

Recap: Lambertian (Diffuse) Term

Produces diffuse appearance

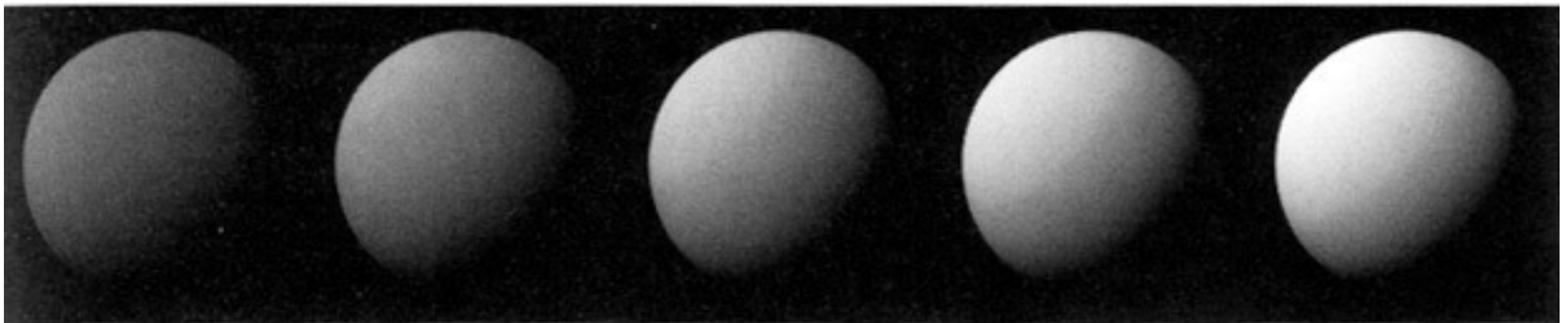

k_d \longrightarrow

[Foley et al.]

Specular Term (Blinn-Phong)

Intensity **depends** on view direction

- Bright near mirror reflection direction

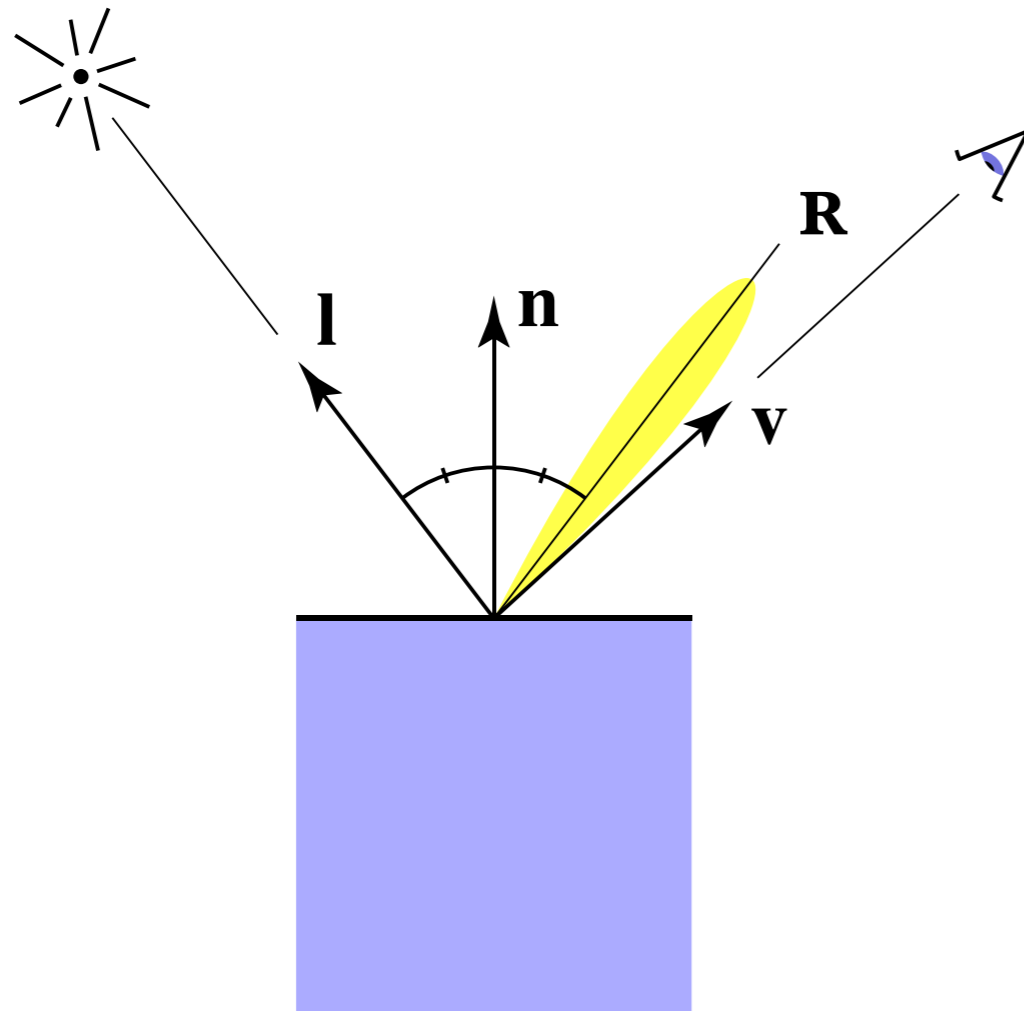

Specular Term (Blinn-Phong)

V close to mirror direction \Leftrightarrow **half vector near normal**

- Measure "near" by dot product of unit vectors

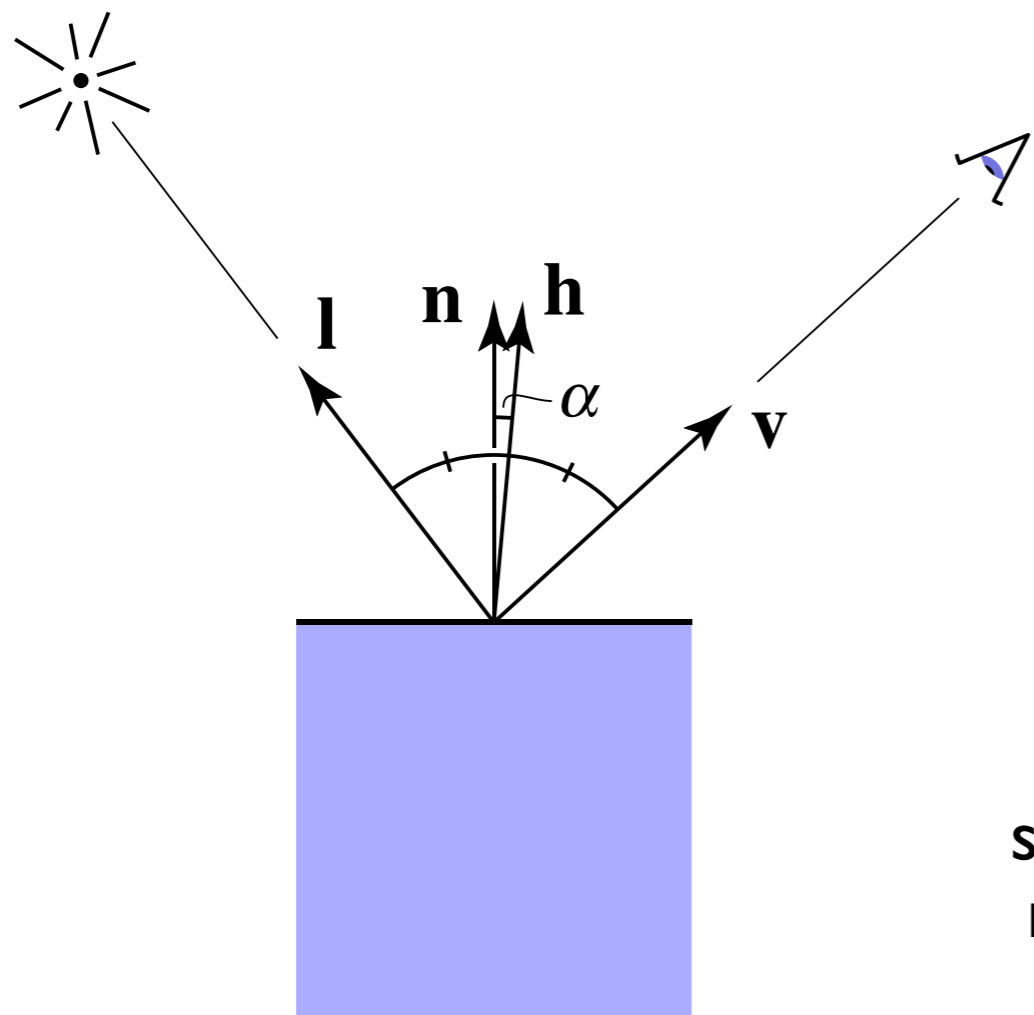

$$\begin{aligned} \mathbf{h} &= \text{bisector}(\mathbf{v}, \mathbf{l}) \\ &\text{(半程向量)} \\ &= \frac{\mathbf{v} + \mathbf{l}}{\|\mathbf{v} + \mathbf{l}\|} \end{aligned}$$

$$\begin{aligned} L_s &= k_s (I/r^2) \max(0, \cos \alpha)^p \\ &= k_s (I/r^2) \max(0, \mathbf{n} \cdot \mathbf{h})^p \end{aligned}$$

↑
specularly
reflected
light

↑
specular
coefficient

Cosine Power Plots

Increasing p narrows the reflection lobe

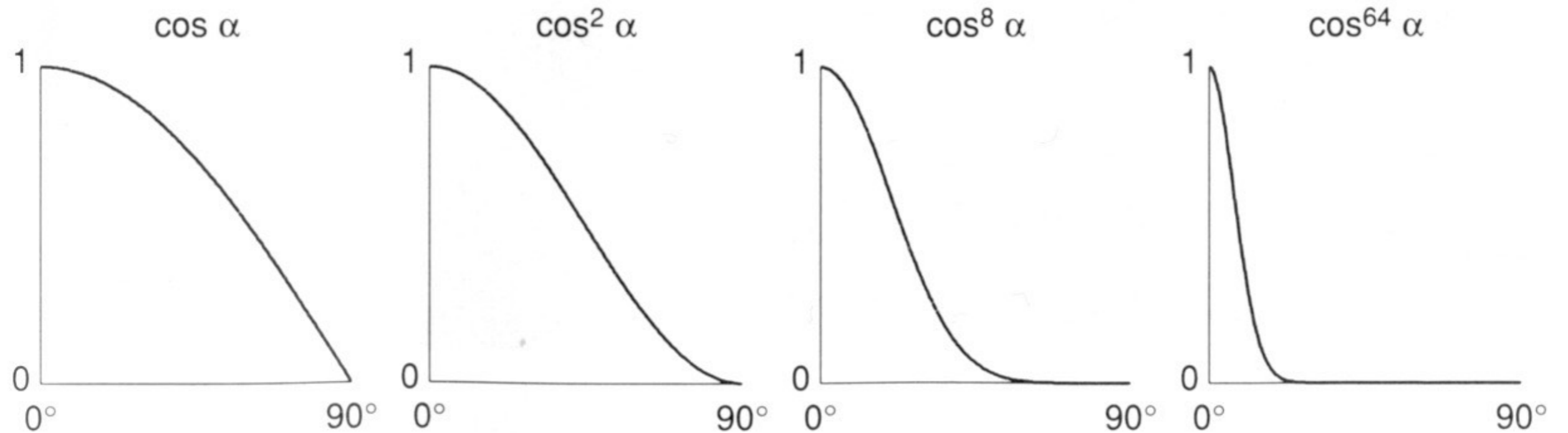

[Foley et al.]

Specular Term (Blinn-Phong)

Blinn-Phong $L_s = k_s (I/r^2) \max(0, \mathbf{n} \cdot \mathbf{h})^p$

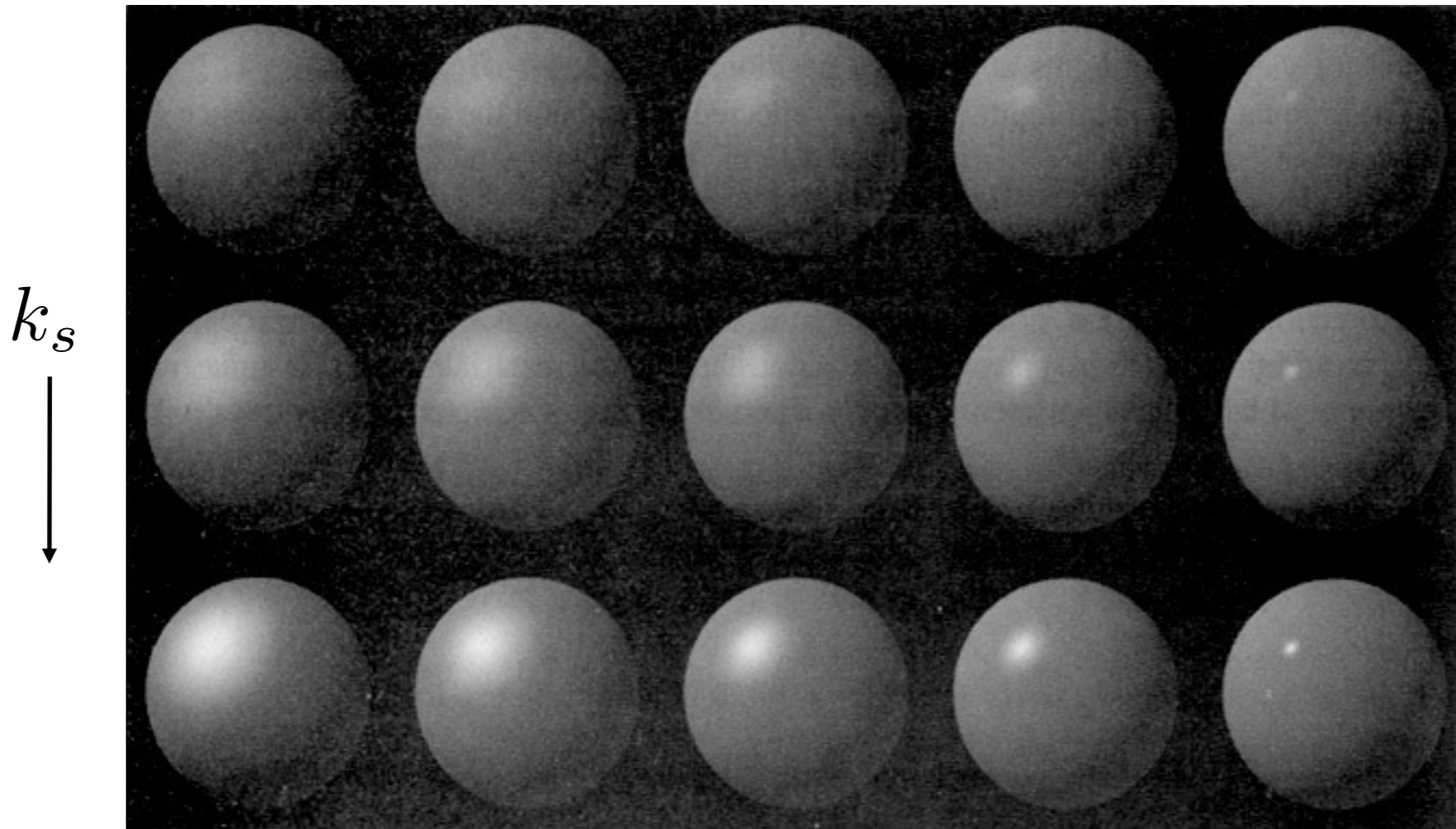

Note: showing
Ld + Ls together

p \longrightarrow

[Foley et al.]

Ambient Term

Shading that does not depend on anything

- Add constant color to account for disregarded illumination and fill in black shadows
- This is approximate / fake!

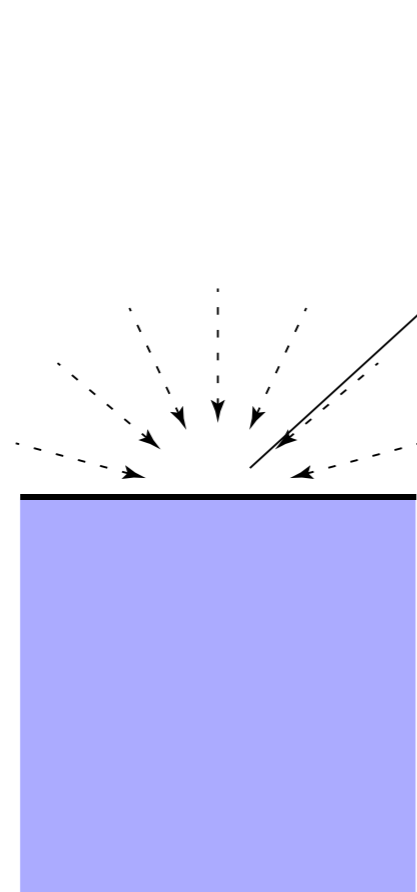

$$L_a = k_a I_a$$

↑
reflected ambient light

↑
ambient coefficient

Blinn-Phong Reflection Model

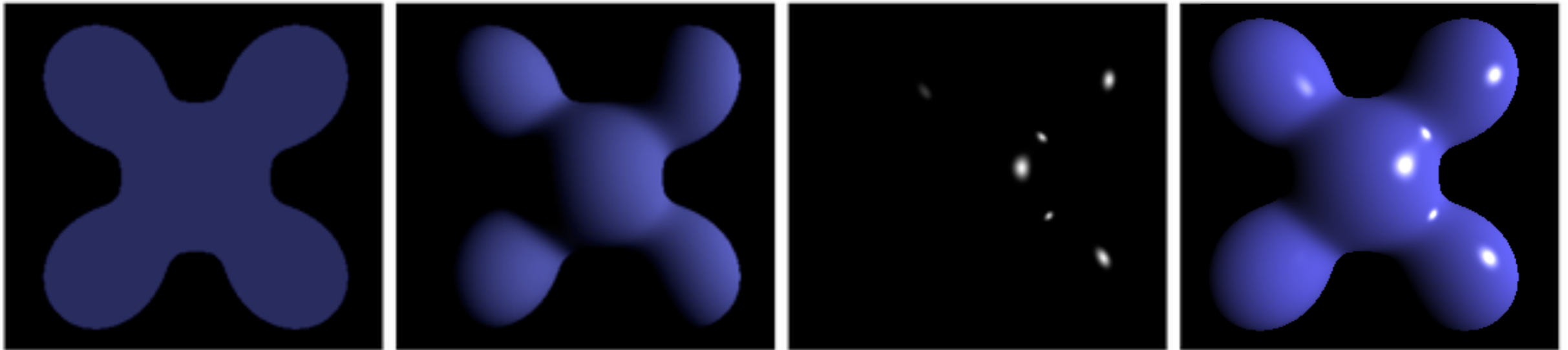

Ambient + Diffuse + Specular = Blinn-Phong Reflection

$$\begin{aligned} L &= L_a + L_d + L_s \\ &= k_a I_a + k_d (I/r^2) \max(0, \mathbf{n} \cdot \mathbf{l}) + k_s (I/r^2) \max(0, \mathbf{n} \cdot \mathbf{h})^p \end{aligned}$$

Questions?

Shading Frequencies

Shading Frequencies

What caused the shading difference?

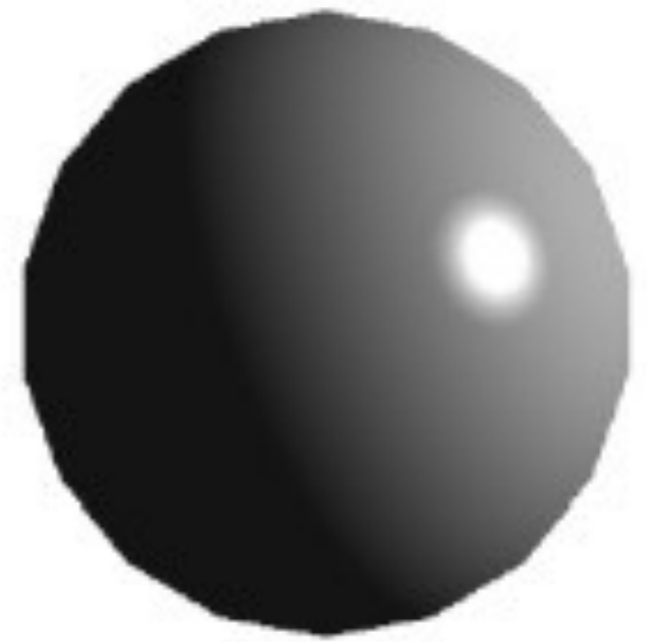

Shade each triangle (flat shading)

Flat shading

- Triangle face is flat — one normal vector
- Not good for smooth surfaces

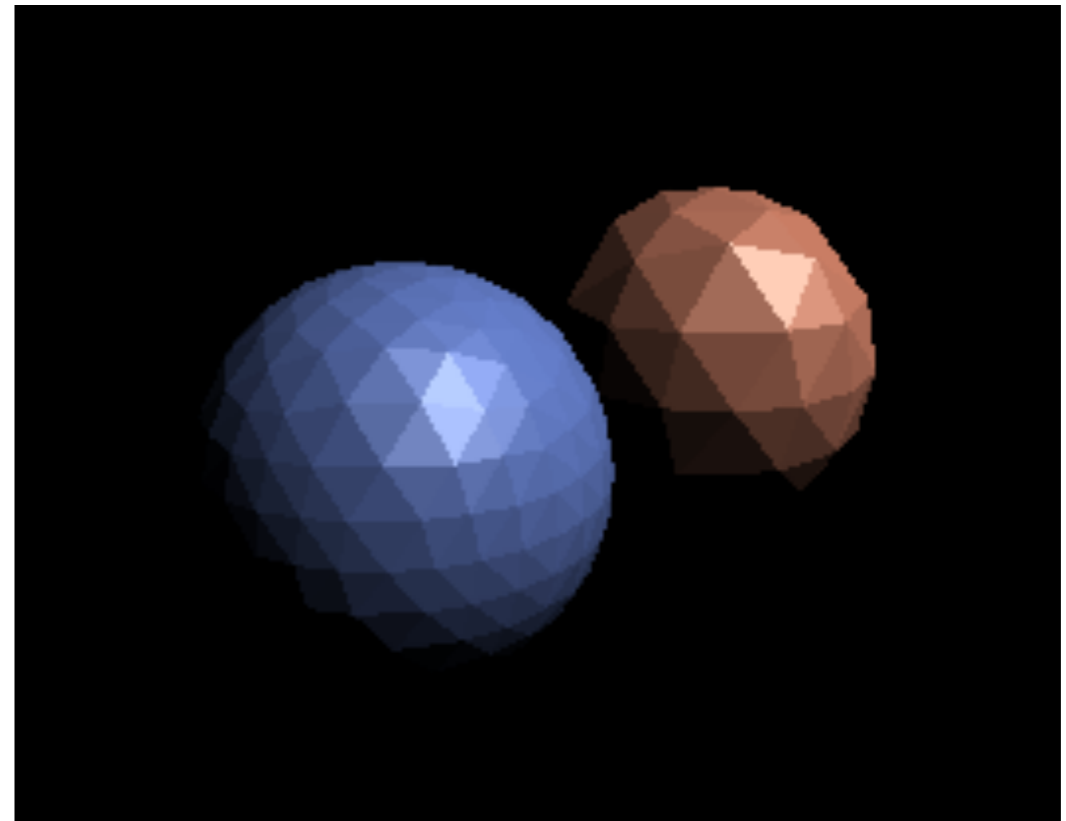

Shade each vertex (Gouraud shading)

Gouraud shading

- **Interpolate** colors from vertices across triangle
- Each vertex has a normal vector (how?)

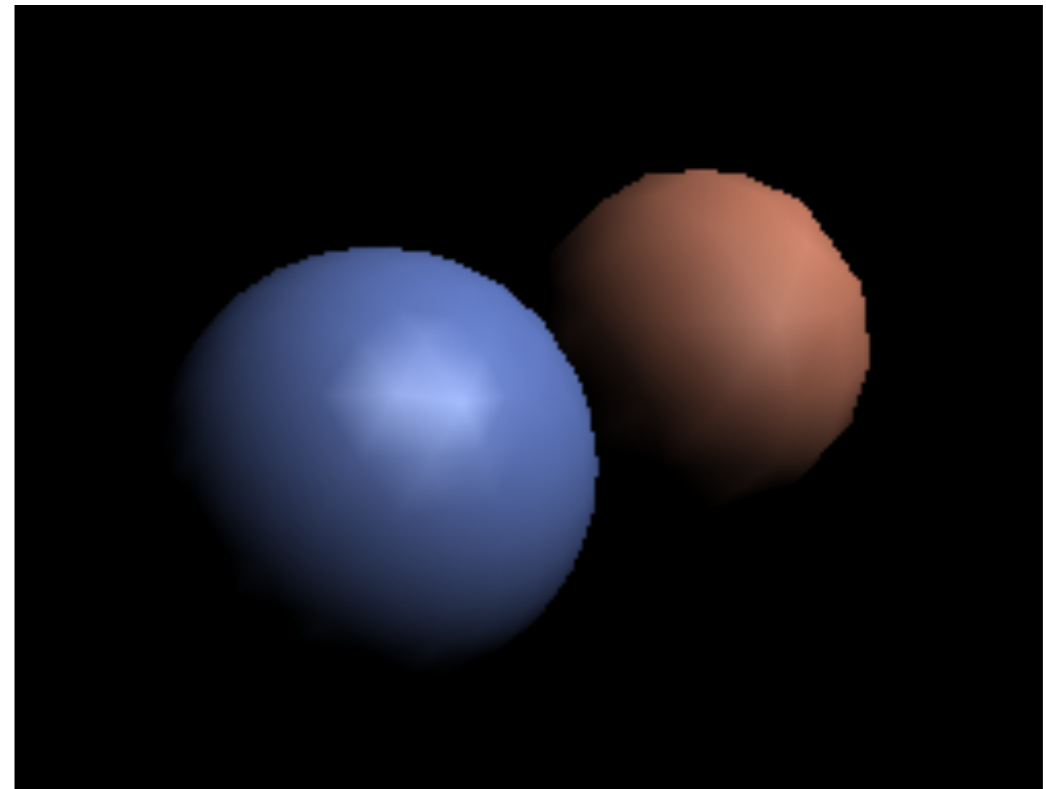

Shade each pixel (Phong shading)

Phong shading

- Interpolate normal vectors across each triangle
- Compute full shading model at each pixel
- Not the **Blinn-Phong Reflectance Model**

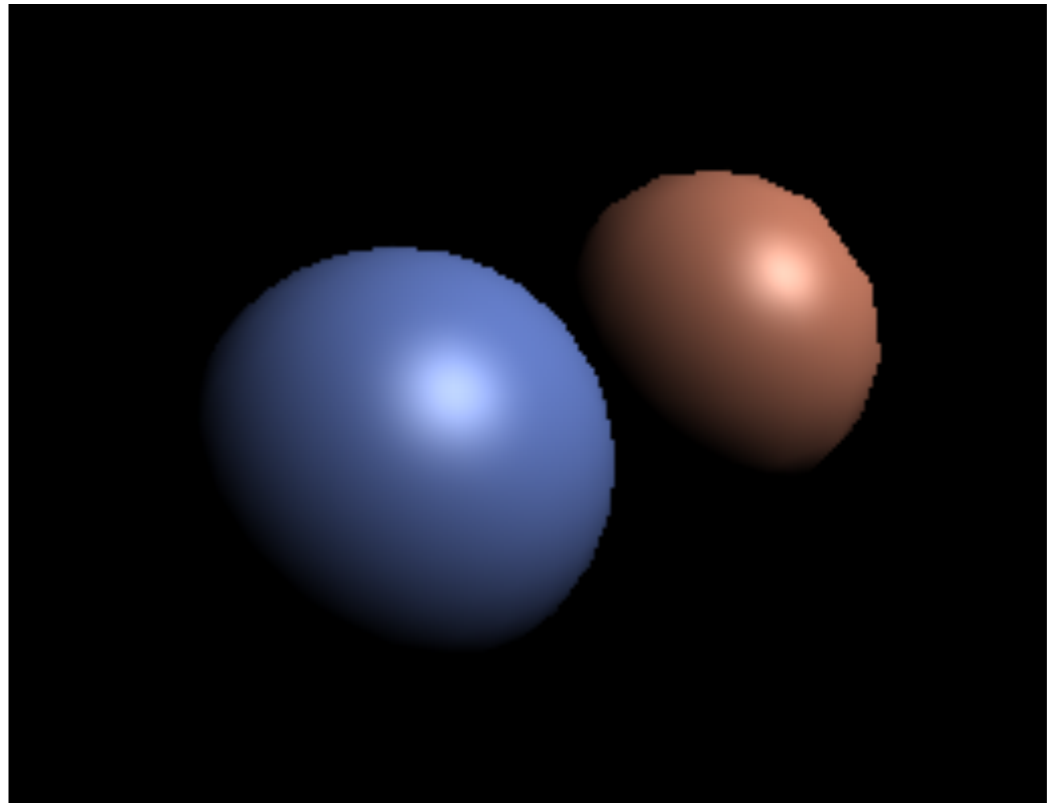

Shading Frequency: Face, Vertex or Pixel

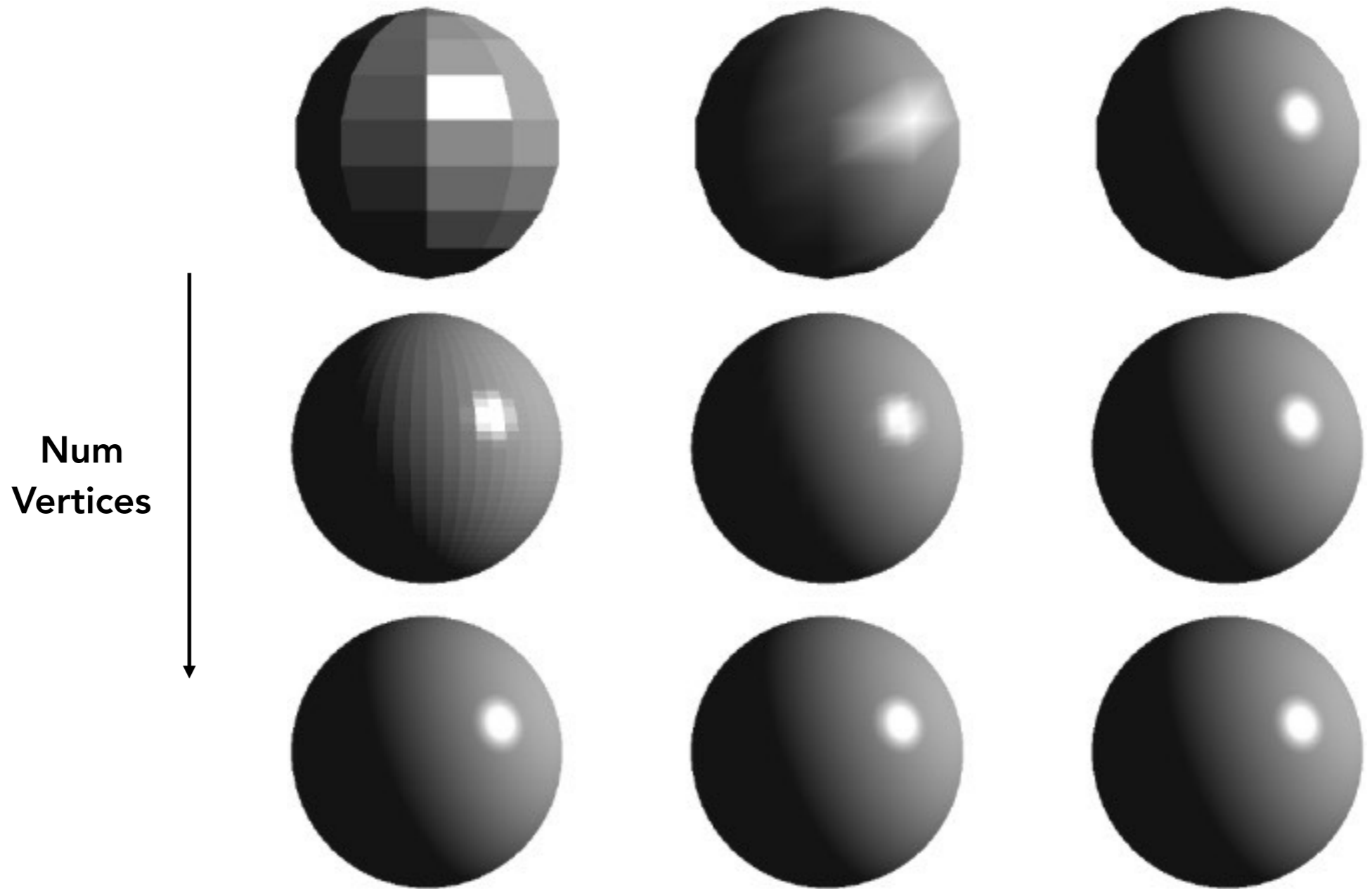

Num
Vertices

Shading freq. : Face
Shading type : Flat

Vertex
Gouraud

Pixel
Phong

Defining Per-Vertex Normal Vectors

Best to get vertex normals from the underlying geometry

- e.g. consider a sphere

Otherwise have to infer vertex normals from triangle faces

- Simple scheme: **average surrounding face normals**

$$N_v = \frac{\sum_i N_i}{\|\sum_i N_i\|}$$

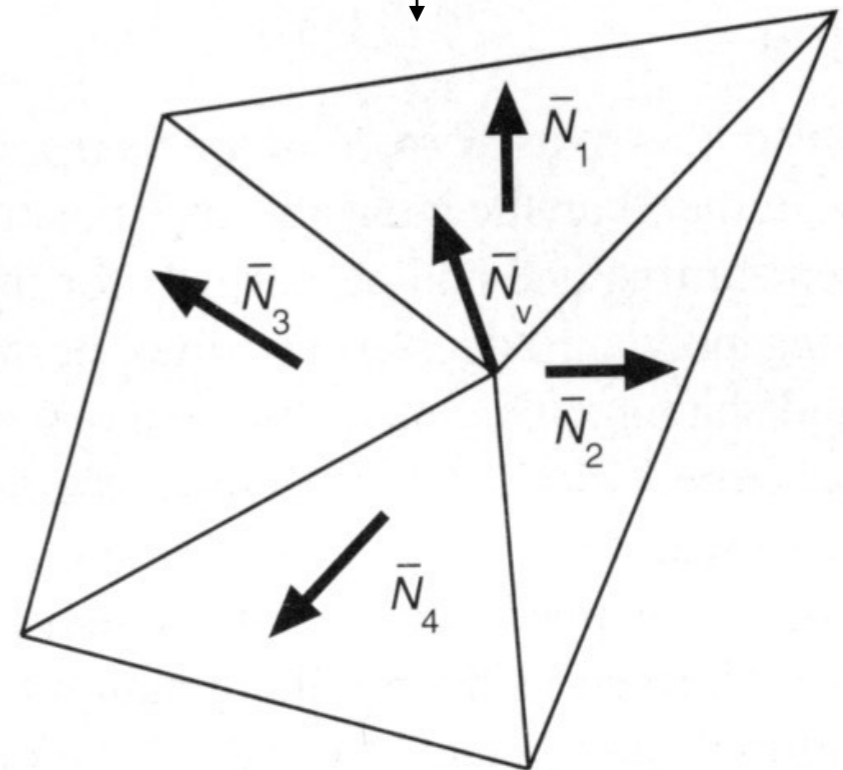
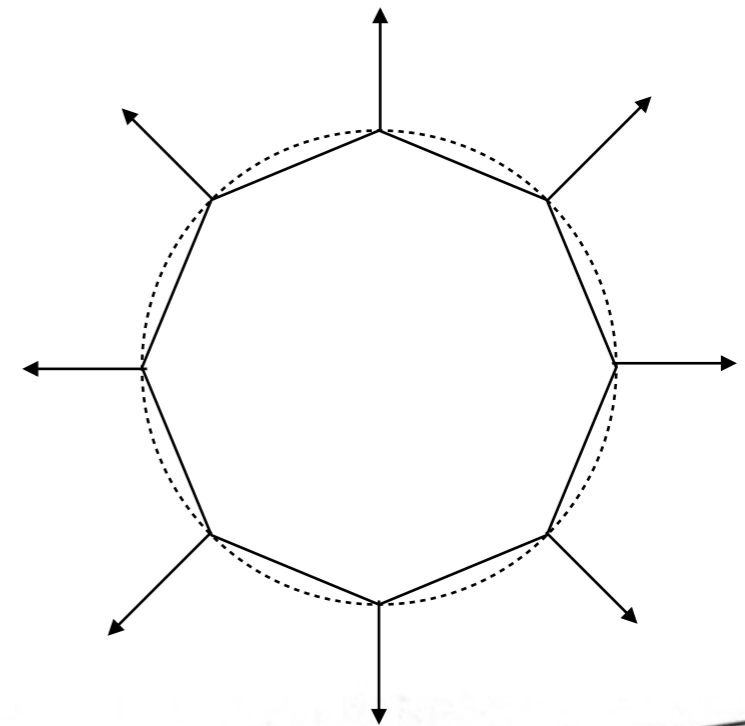

Defining Per-Pixel Normal Vectors

Barycentric interpolation (introducing soon)
of vertex normals

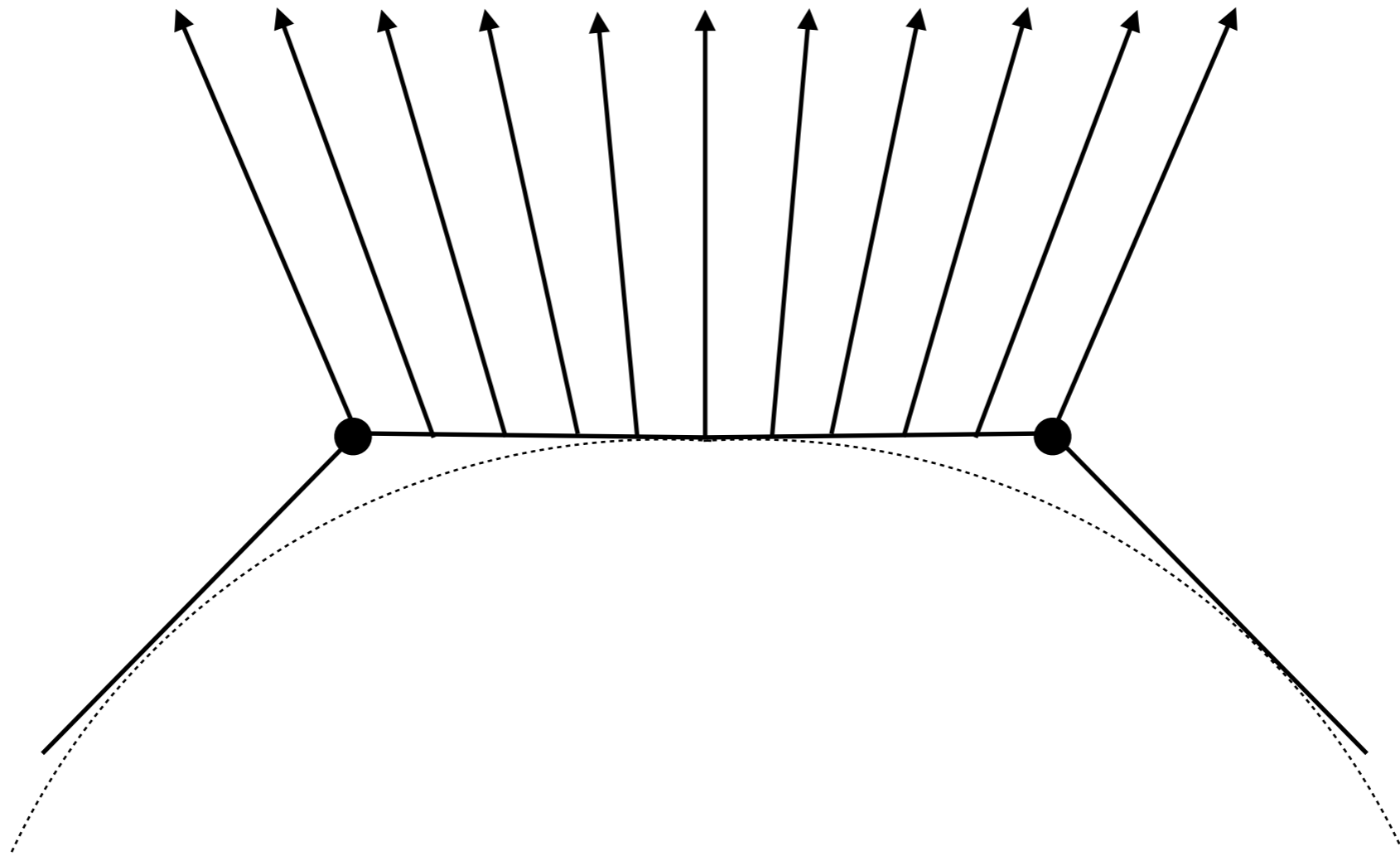

Don't forget to **normalize** the interpolated directions

Graphics (**Real-time Rendering**) Pipeline

Graphics Pipeline

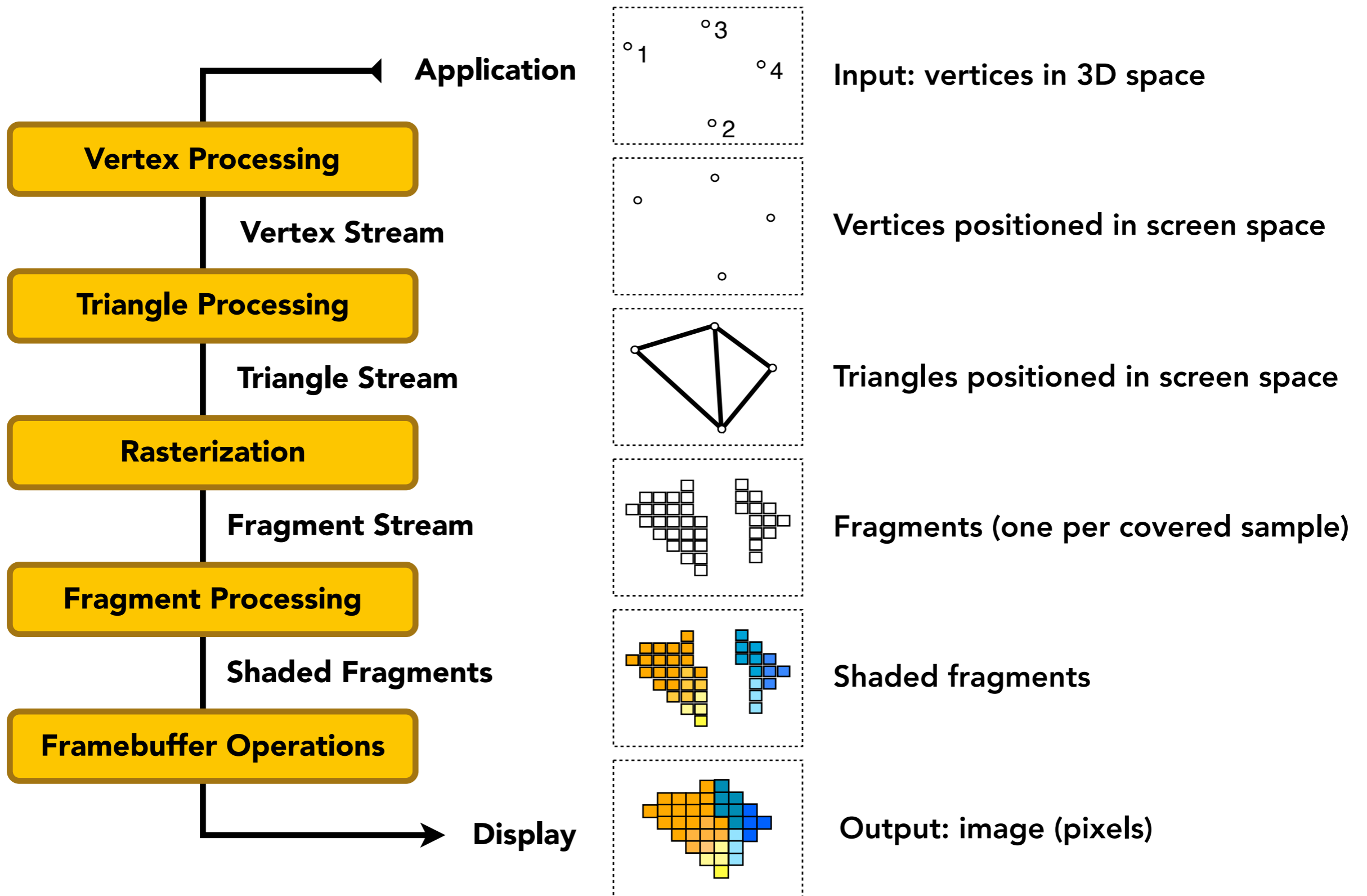

Graphics Pipeline

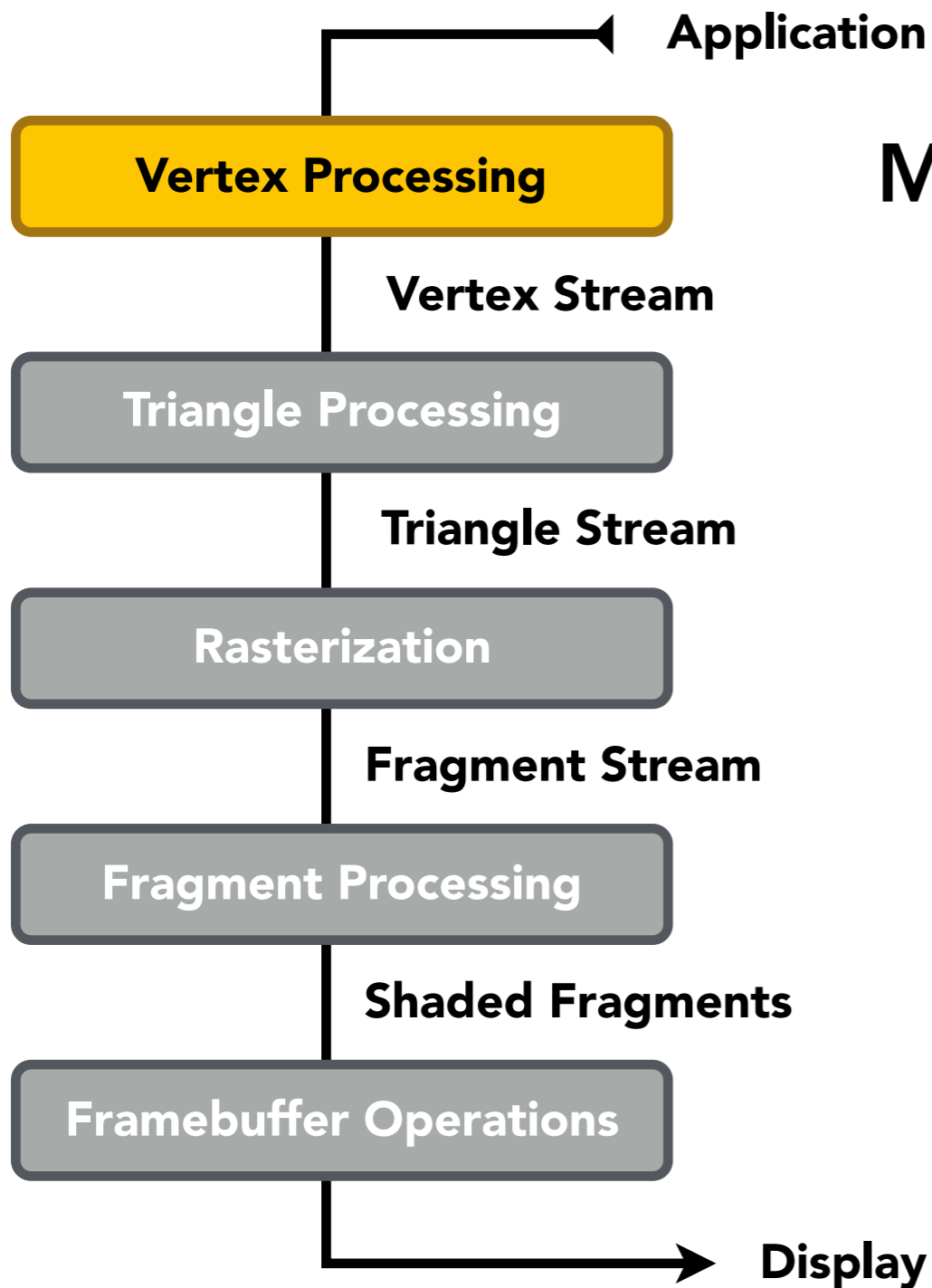

Model, View, Projection transforms

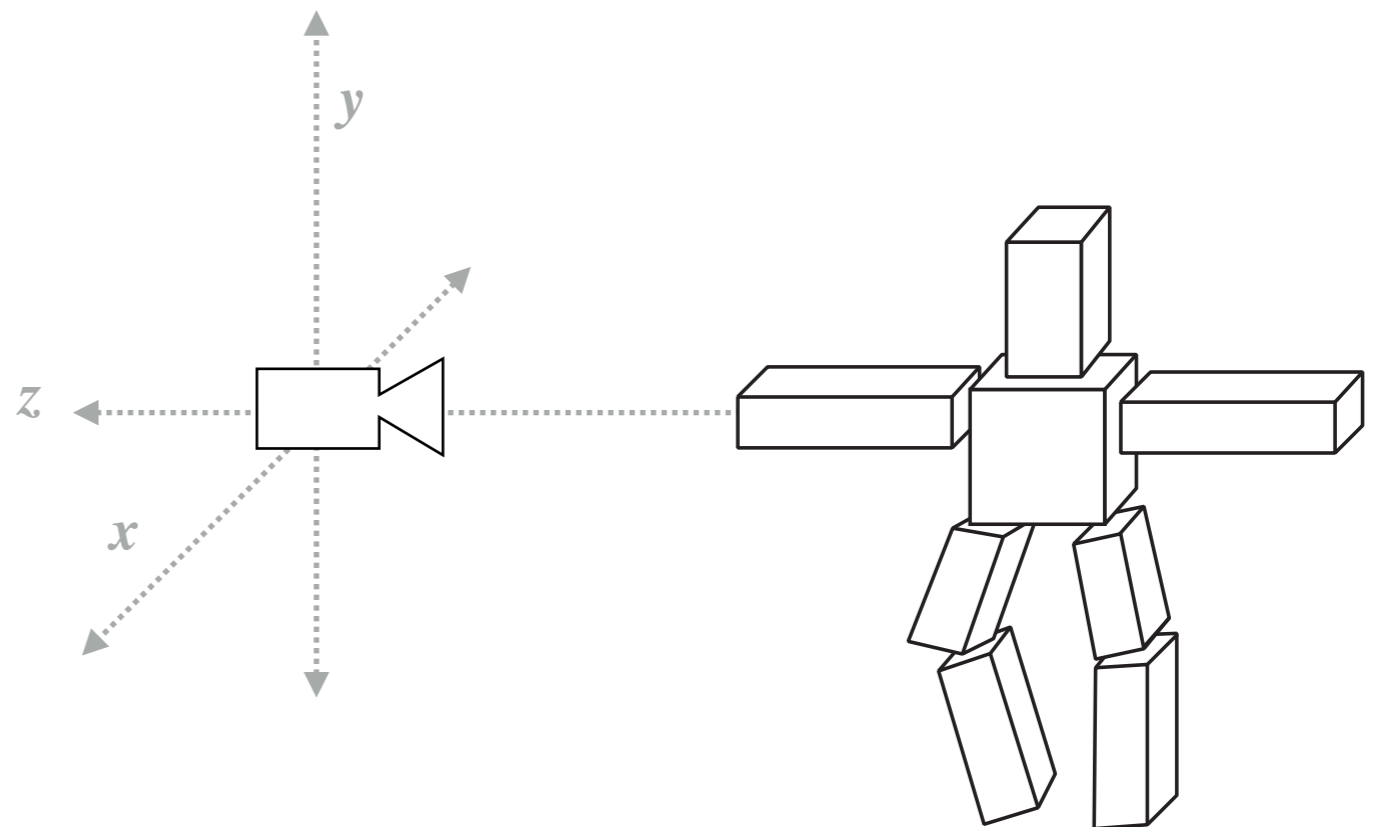

Graphics Pipeline

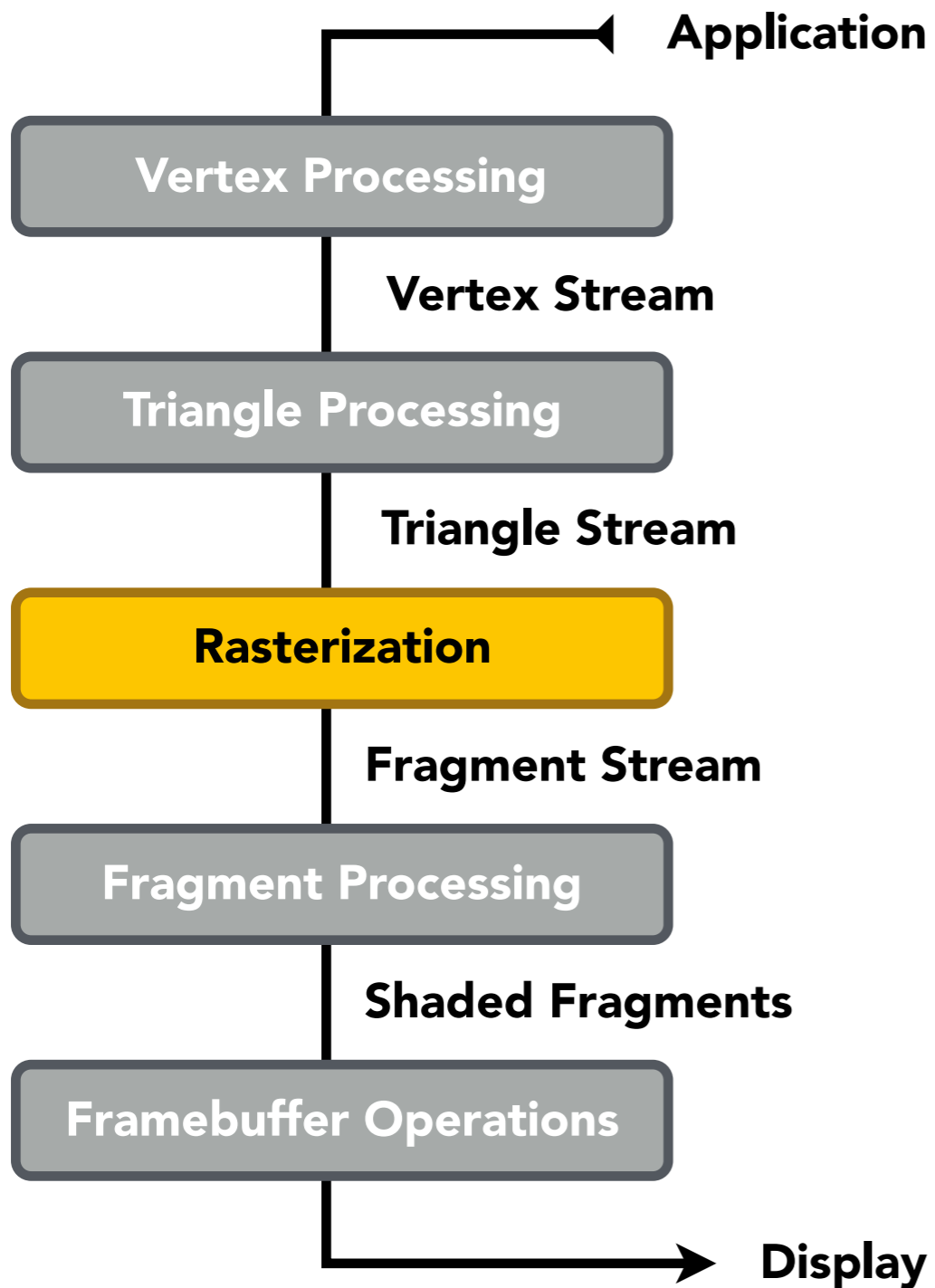

Sampling triangle coverage

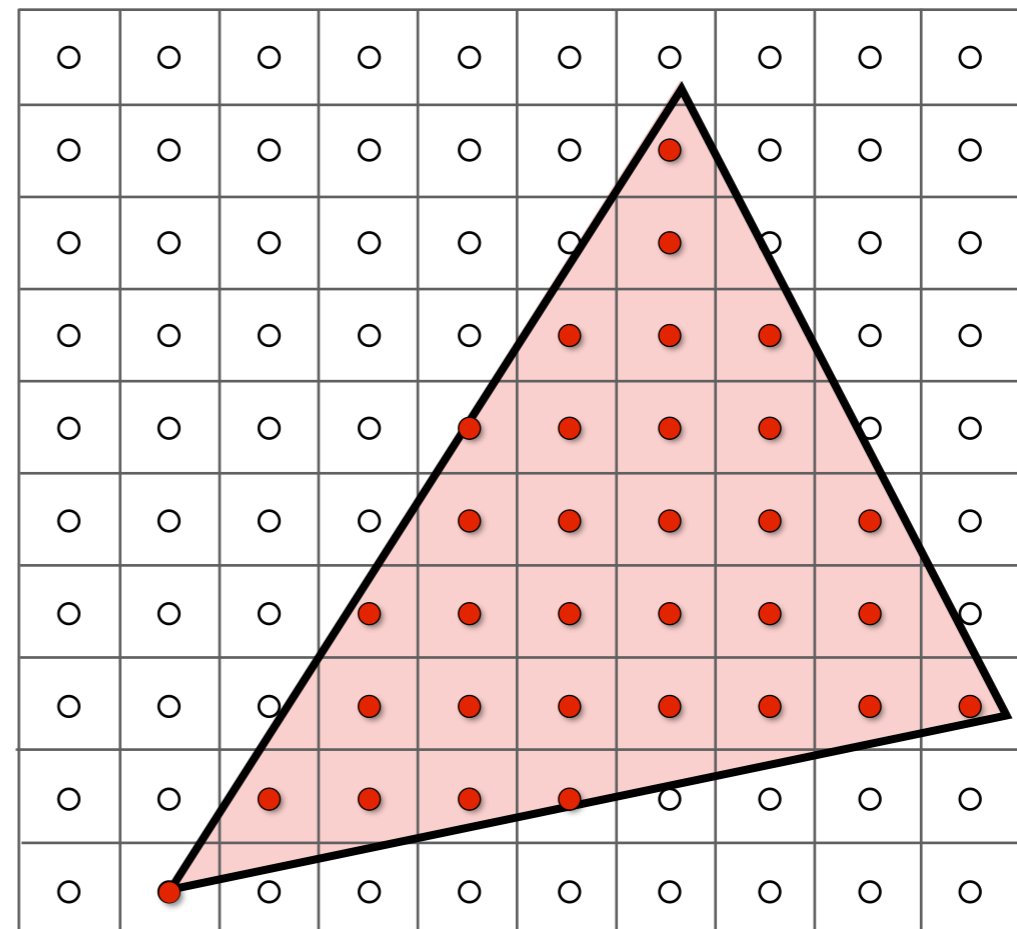

Rasterization Pipeline

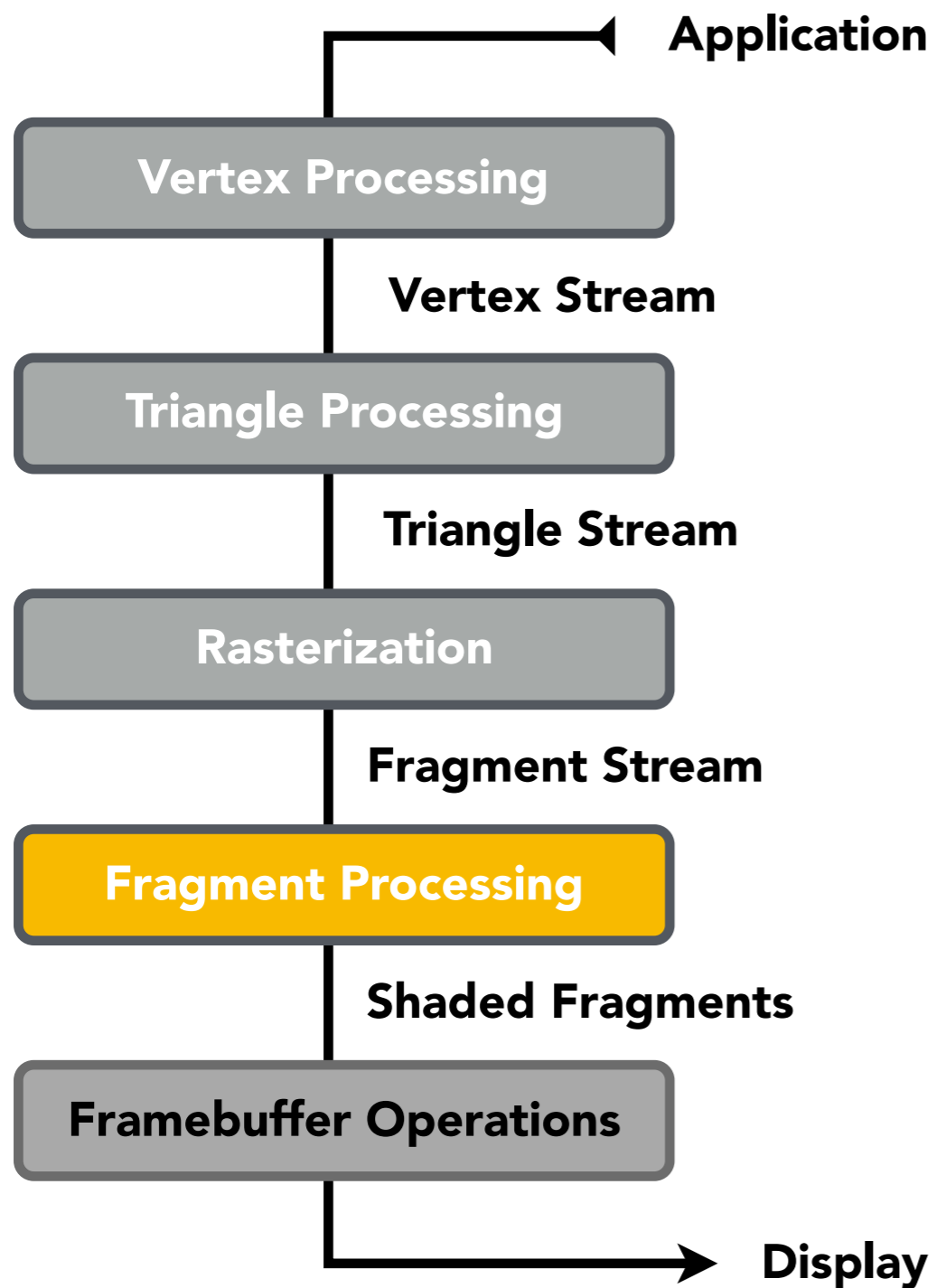

Z-Buffer Visibility Tests



Graphics Pipeline

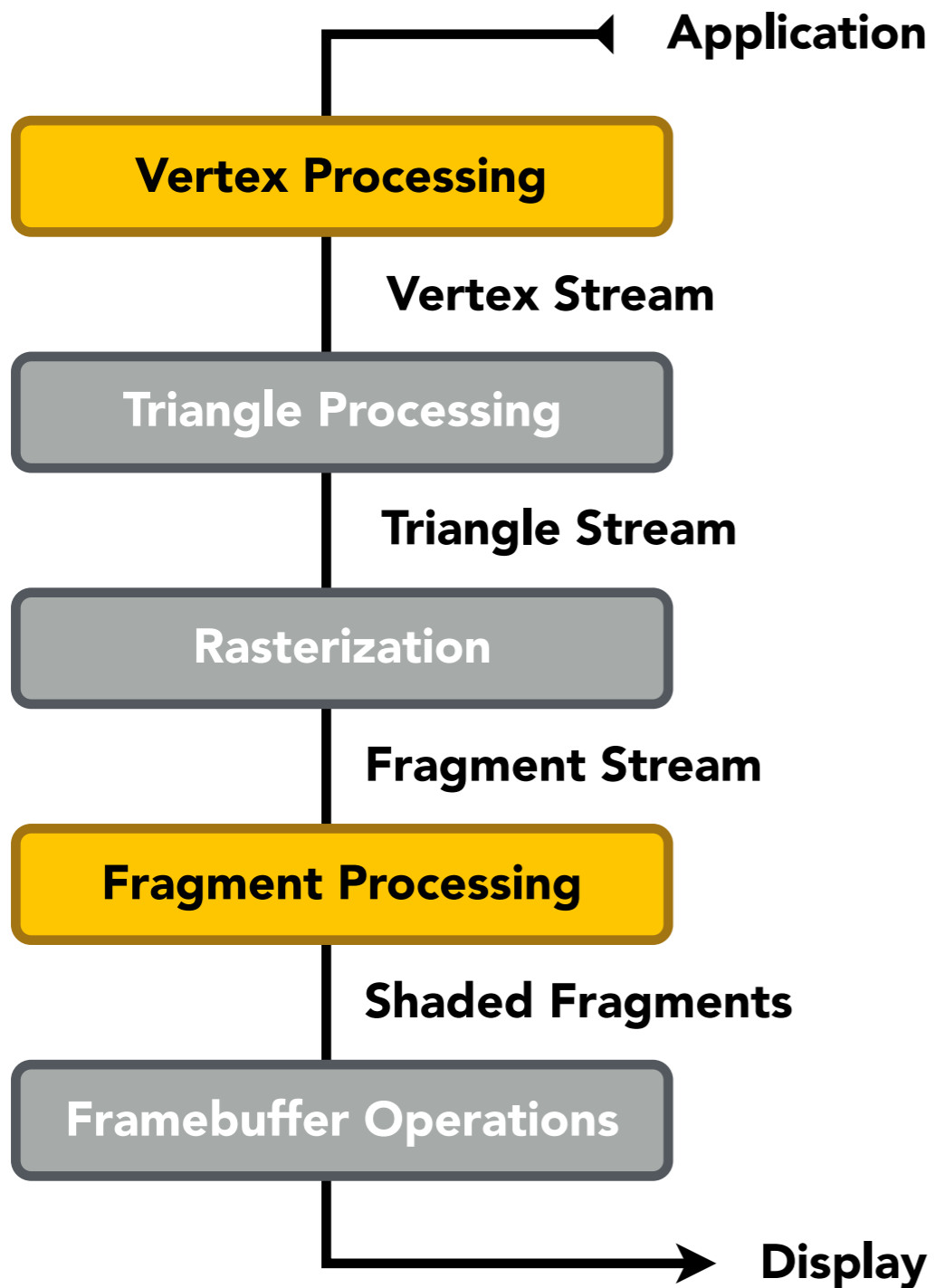

Shading

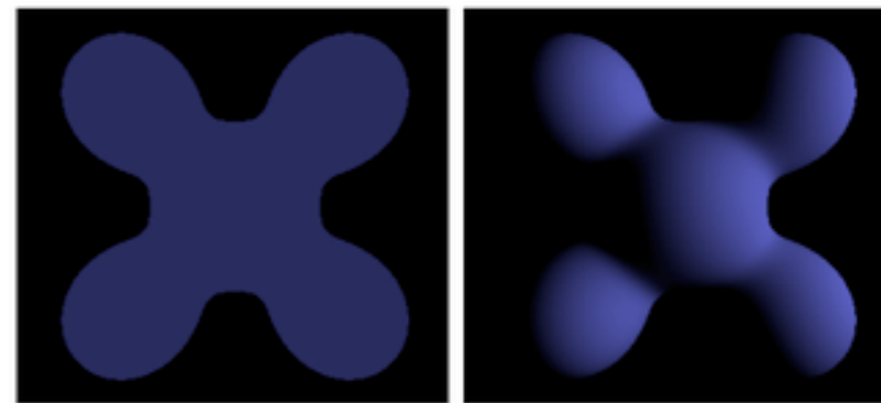

Ambient + Diffuse

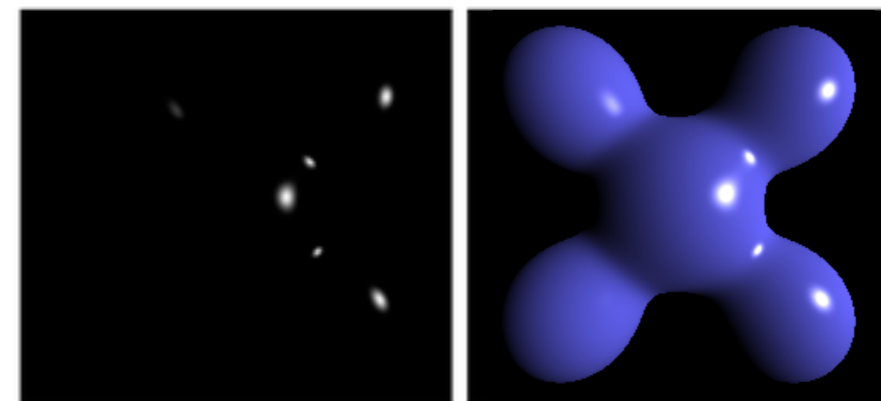

+ Specular = Blinn-Phong Reflectance Model

Graphics Pipeline

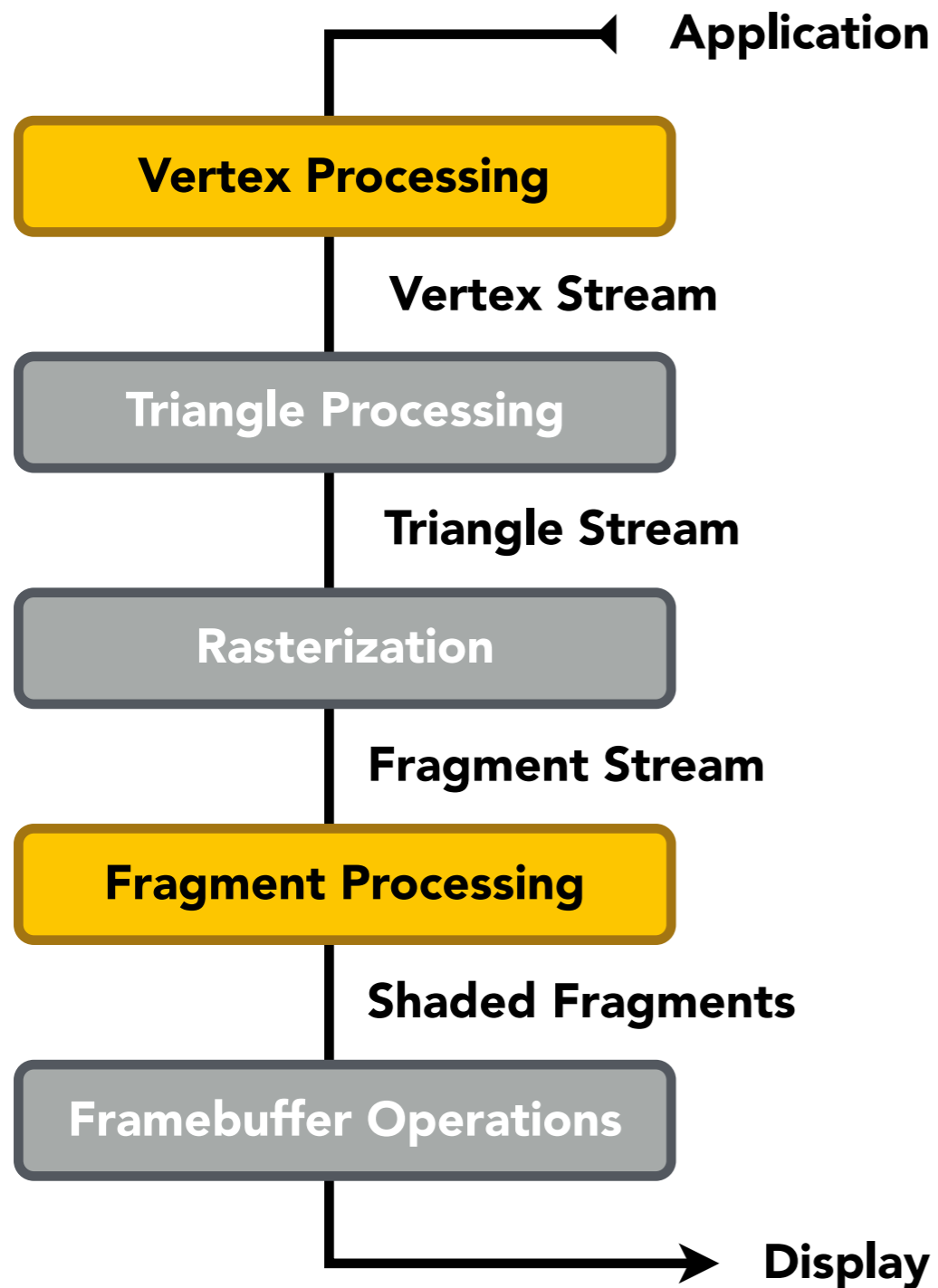

Texture mapping
(introducing soon)



Shader Programs

- Program vertex and fragment processing stages
- Describe operation on a single vertex (or fragment)

Example GLSL fragment shader program

```
uniform sampler2D myTexture;
uniform vec3 lightDir;
varying vec2 uv;
varying vec3 norm;

void diffuseShader()
{
    vec3 kd;
    kd = texture2d(myTexture, uv);
    kd *= clamp(dot(-lightDir, norm), 0.0, 1.0);
    gl_FragColor = vec4(kd, 1.0);
}
```

- **Shader function executes once per fragment.**
- **Outputs color of surface at the current fragment's screen sample position.**
- **This shader performs a texture lookup to obtain the surface's material color at this point, then performs a diffuse lighting calculation.**

Shader Programs

- Program vertex and fragment processing stages
- Describe operation on a single vertex (or fragment)

Example GLSL fragment shader program

```
uniform sampler2D myTexture;    // program parameter
uniform vec3 lightDir;         // program parameter
varying vec2 uv;               // per fragment value (interp. by rasterizer)
varying vec3 norm;             // per fragment value (interp. by rasterizer)

void diffuseShader()
{
    vec3 kd;
    kd = texture2d(myTexture, uv); // material color from texture
    kd *= clamp(dot(-lightDir, norm), 0.0, 1.0); // Lambertian shading model
    gl_FragColor = vec4(kd, 1.0); // output fragment color
}
```

Snail Shader Program

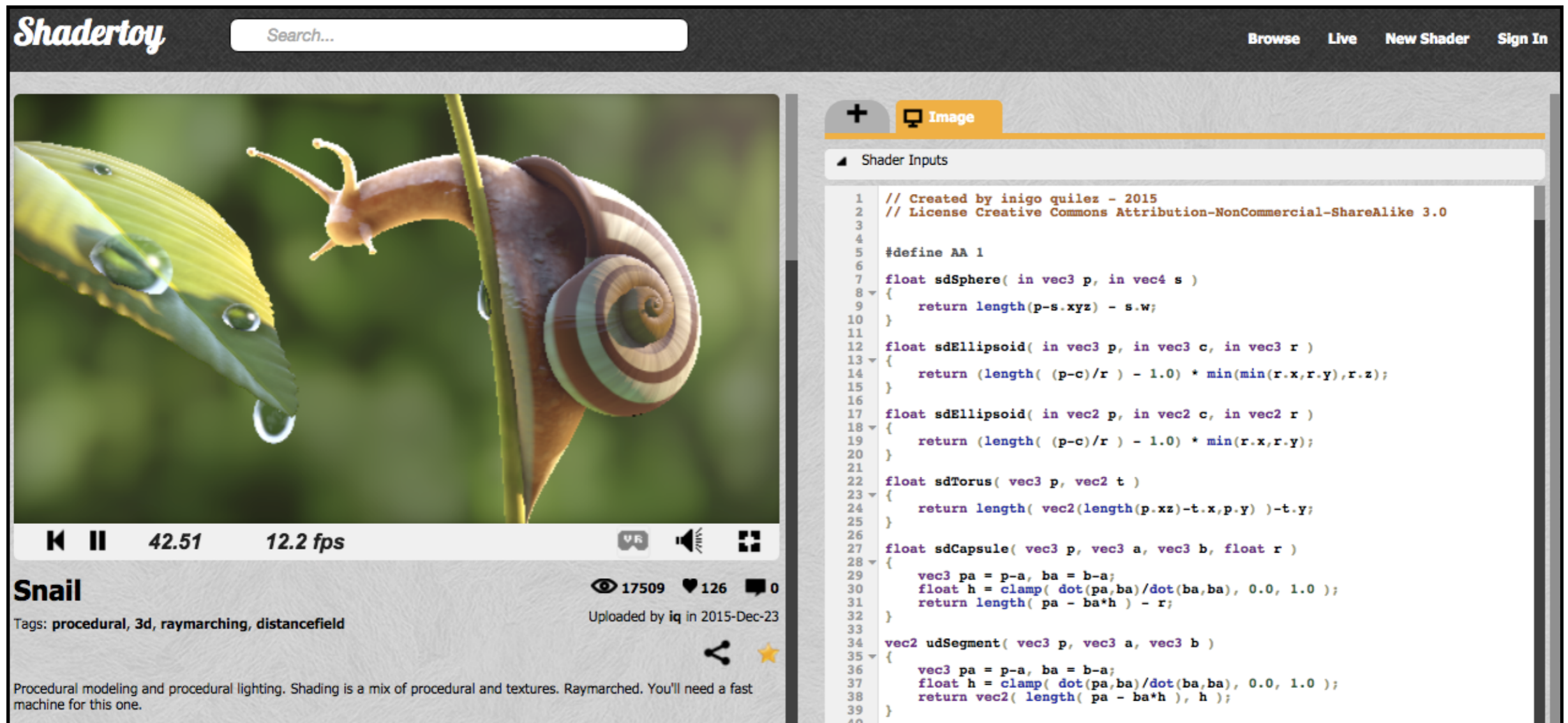

Shadertoy Search... Browse Live New Shader Sign In

Snail
Tags: procedural, 3d, raymarching, distancefield
Viewed 17509 times, 126 likes, 0 comments
Uploaded by iq in 2015-Dec-23

Procedural modeling and procedural lighting. Shading is a mix of procedural and textures. Raymarched. You'll need a fast machine for this one.

```
1 // Created by inigo quilez - 2015
2 // License Creative Commons Attribution-NonCommercial-ShareAlike 3.0
3
4
5 #define AA 1
6
7 float sdSphere( in vec3 p, in vec4 s )
8 {
9     return length(p-s.xyz) - s.w;
10 }
11
12 float sdEllipsoid( in vec3 p, in vec3 c, in vec3 r )
13 {
14     return (length( (p-c)/r ) - 1.0) * min(min(r.x,r.y),r.z);
15 }
16
17 float sdEllipsoid( in vec2 p, in vec2 c, in vec2 r )
18 {
19     return (length( (p-c)/r ) - 1.0) * min(r.x,r.y);
20 }
21
22 float sdTorus( vec3 p, vec2 t )
23 {
24     return length( vec2(length(p.xz)-t.x,p.y) )-t.y;
25 }
26
27 float sdCapsule( vec3 p, vec3 a, vec3 b, float r )
28 {
29     vec3 pa = p-a, ba = b-a;
30     float h = clamp( dot(pa,ba)/dot(ba,ba), 0.0, 1.0 );
31     return length( pa - ba*h ) - r;
32 }
33
34 vec2 udSegment( vec3 p, vec3 a, vec3 b )
35 {
36     vec3 pa = p-a, ba = b-a;
37     float h = clamp( dot(pa,ba)/dot(ba,ba), 0.0, 1.0 );
38     return vec2( length( pa - ba*h ), h );
39 }
40
```

Inigo Quilez

Procedurally modeled, 800 line shader.

<http://shadertoy.com/view/ld3Gz2>

Snail Shader Program

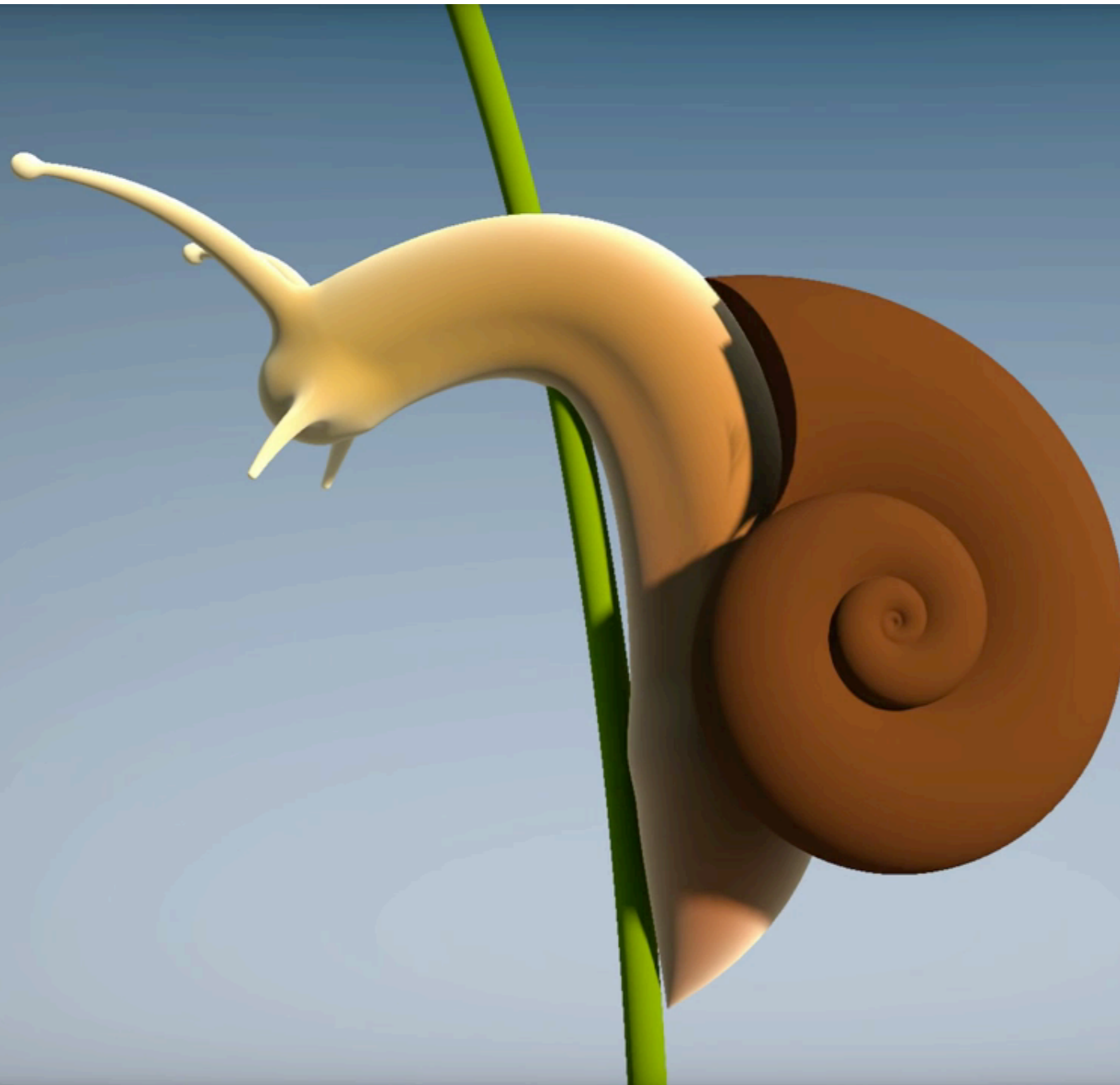

Inigo Quilez, <https://youtu.be/XuSnLbB1j6E>

Goal: Highly Complex 3D Scenes in Realtime

- 100's of thousands to millions of triangles in a scene
- Complex vertex and fragment shader computations
- High resolution (2-4 megapixel + supersampling)
- 30-60 frames per second (even higher for VR)



Graphics Pipeline Implementation: GPUs

Specialized processors for executing graphics pipeline computations



**Discrete GPU Card
(NVIDIA GeForce Titan X)**

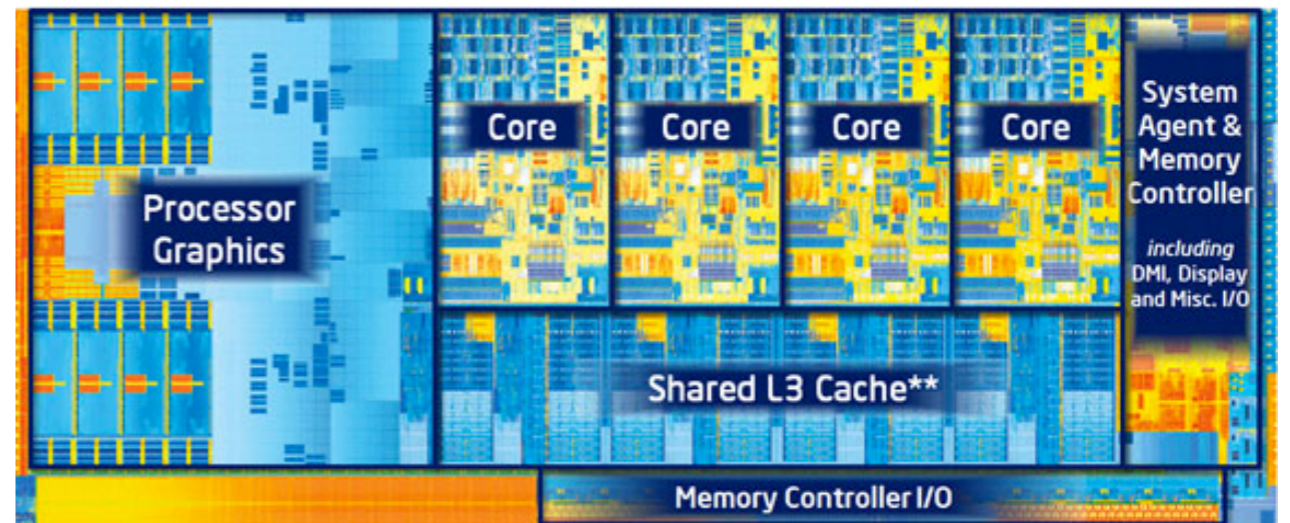

**Integrated GPU:
(Part of Intel CPU die)**

GPU: Heterogeneous, Multi-Core Processor

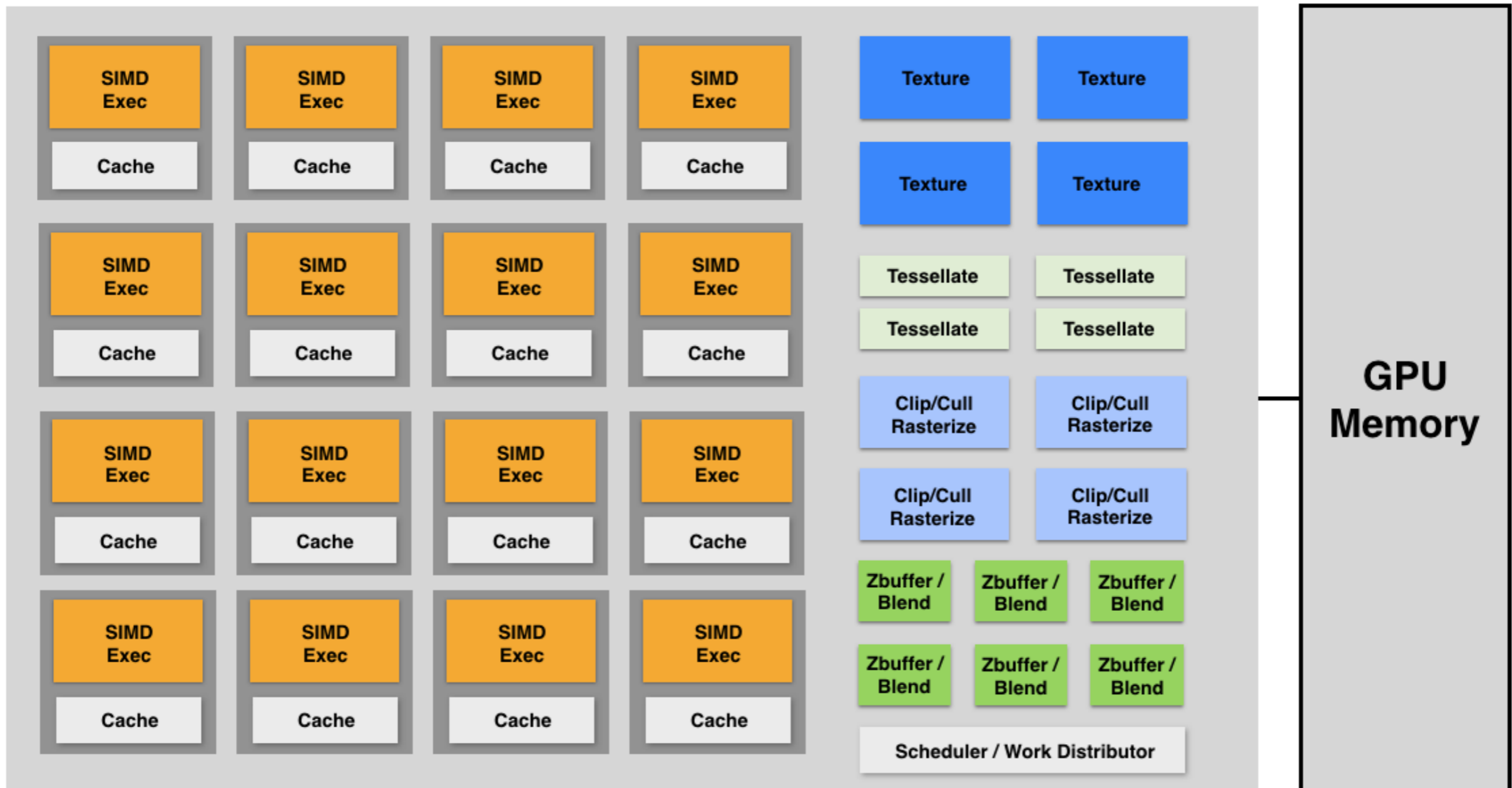

Modern GPUs offer ~2-4 Tera-FLOPs of performance for executing vertex and fragment shader programs

Tera-Op's of fixed-function compute capability over here

Texture Mapping

Different Colors at Different Places?



Pattern on ball

Wood grain on floor

Surfaces are 2D

Surface lives in 3D world space

Every 3D surface point also has a place where it goes in the 2D image (**texture**).

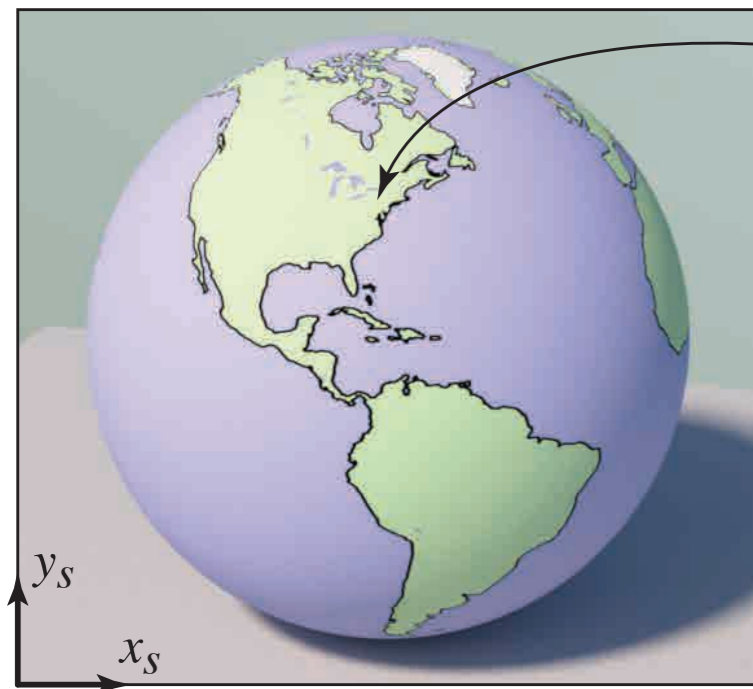

Screen space

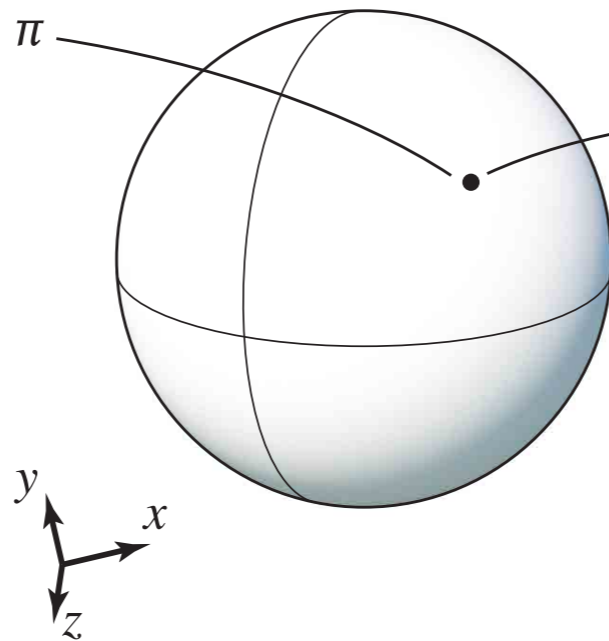

World space

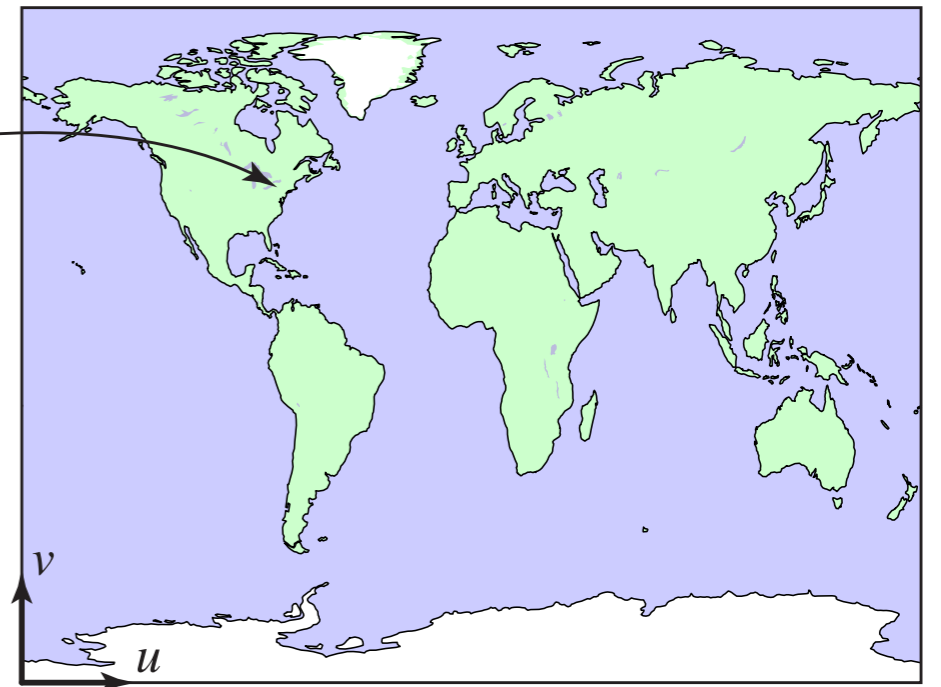

Texture space

Texture Applied to Surface

Rendering without texture



Rendering with texture

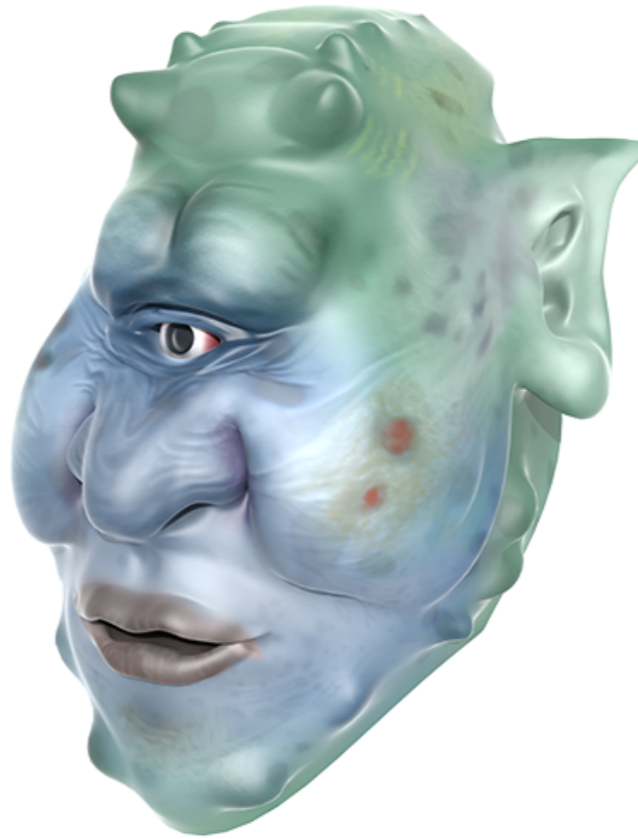

Texture

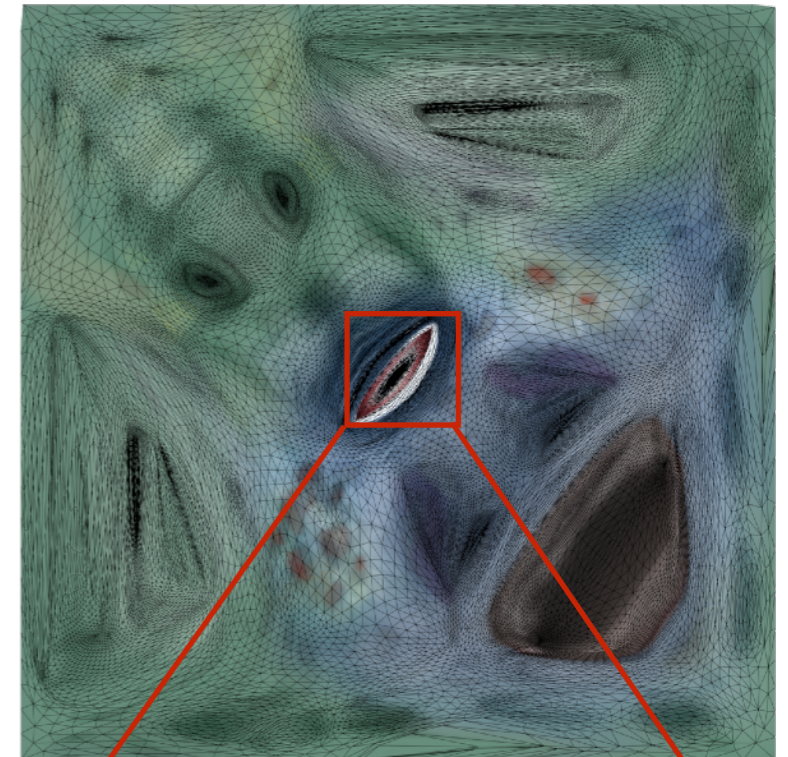

Zoom

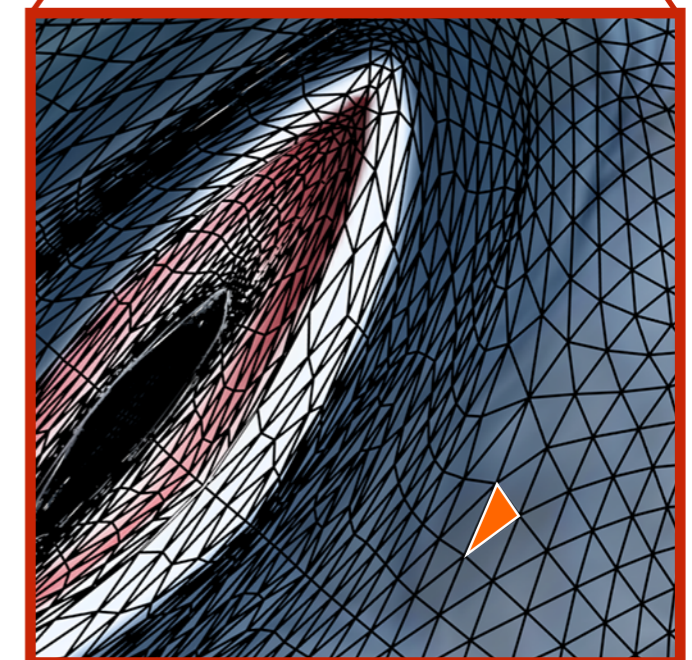
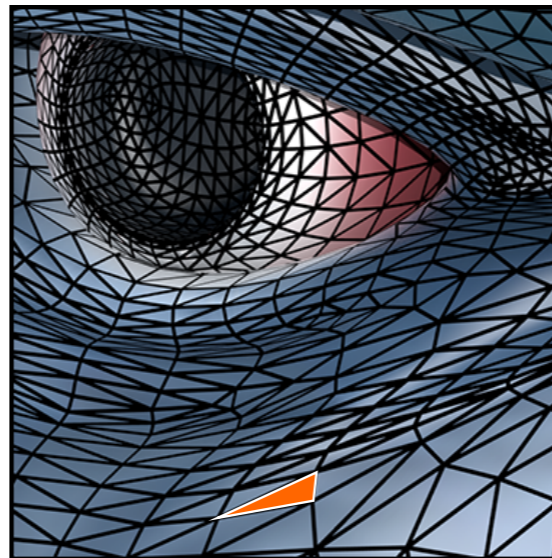
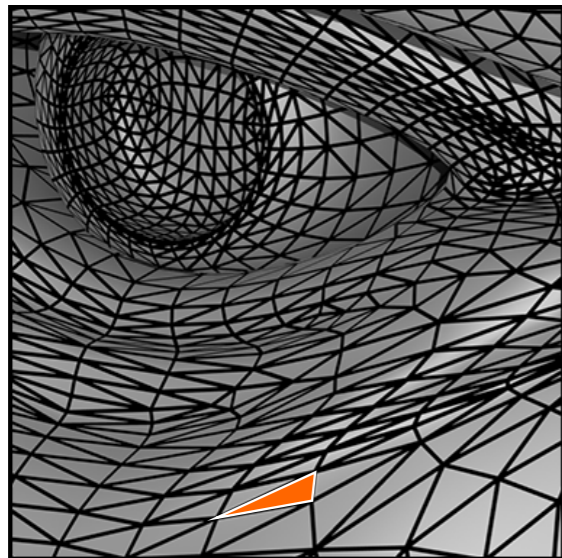

Each triangle "copies" a piece of the texture image to the surface.

Visualization of Texture Coordinates

Each triangle vertex is assigned a texture coordinate (u,v)

Visualization of texture coordinates

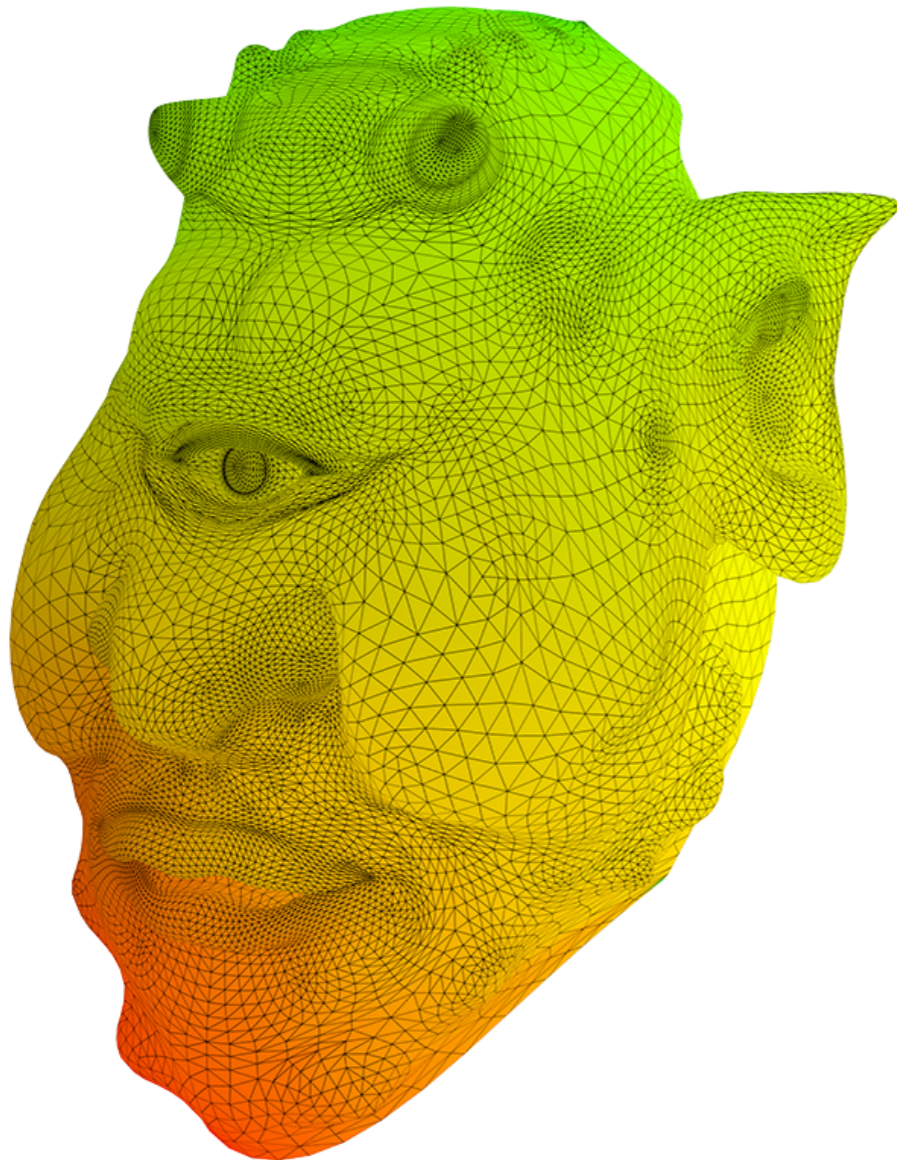

Triangle vertices in texture space

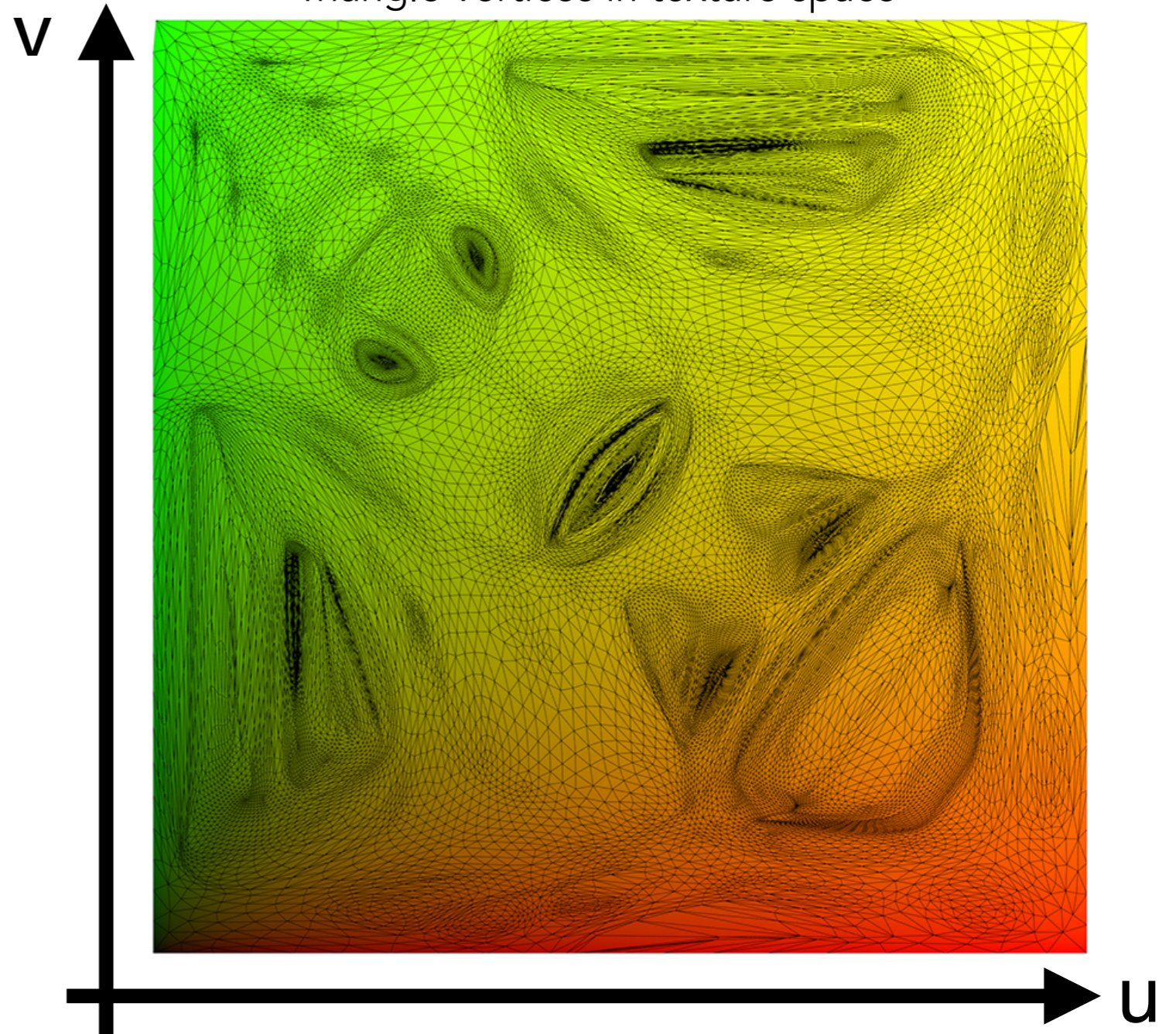

Texture Applied to Surface

Rendered result

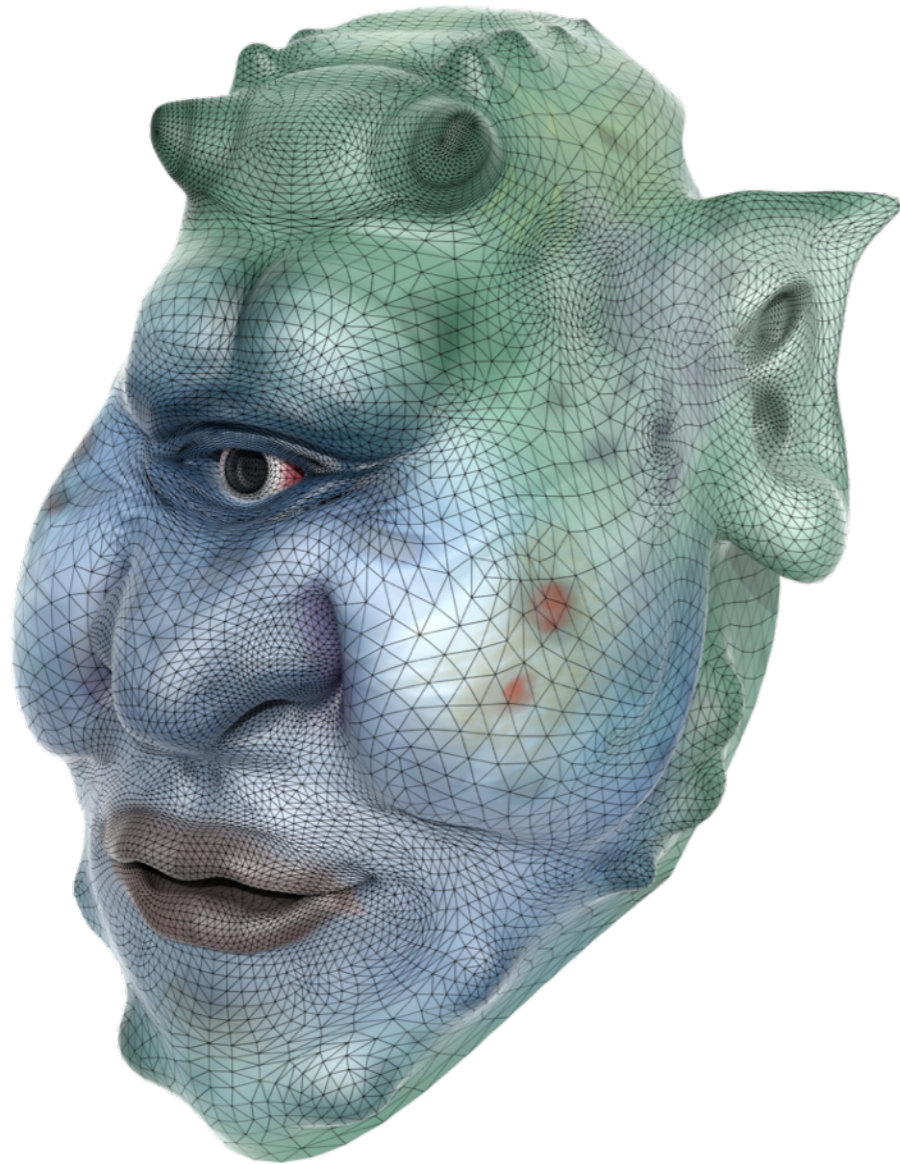

Triangle vertices in texture space

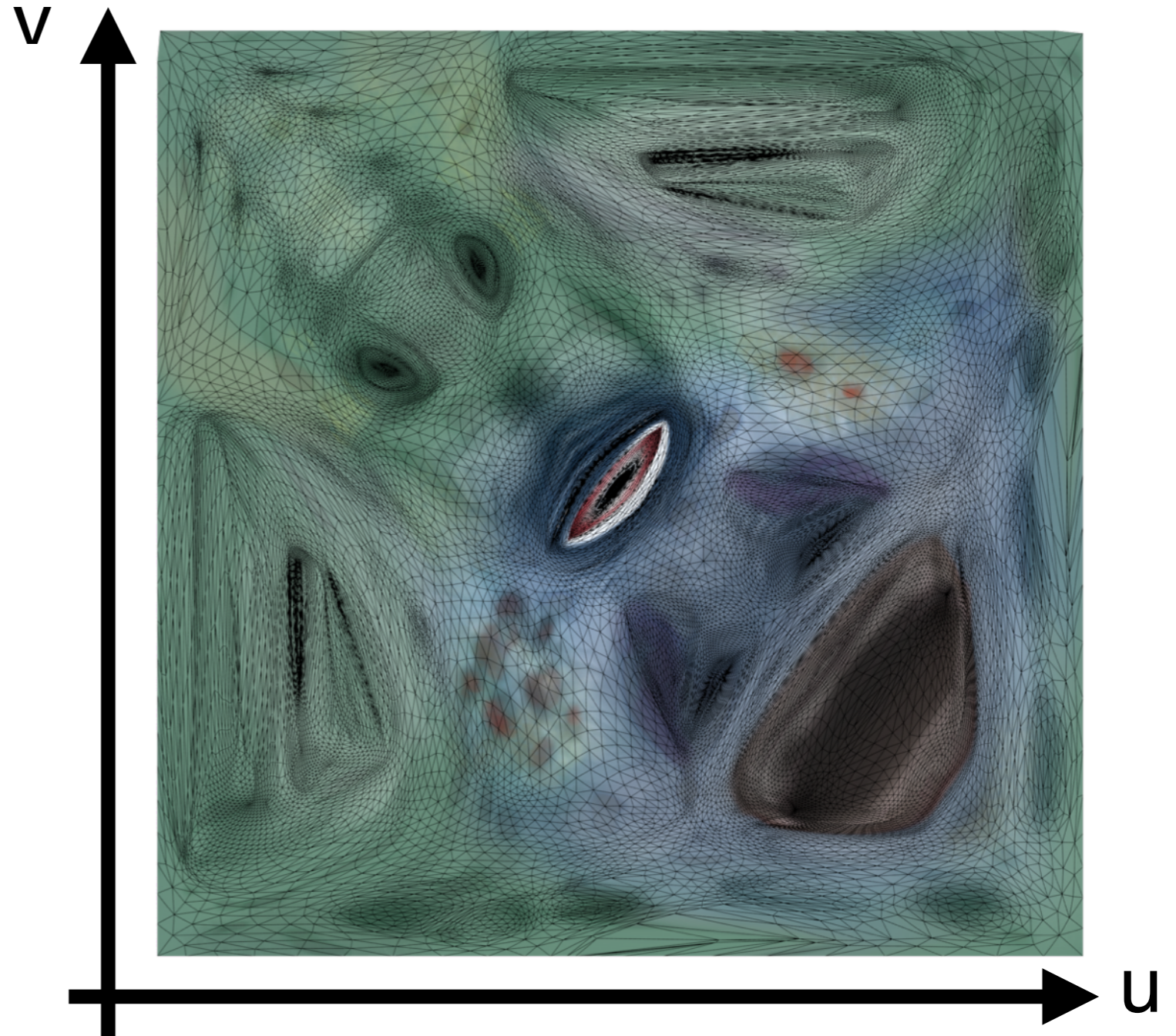

Textures applied to surfaces

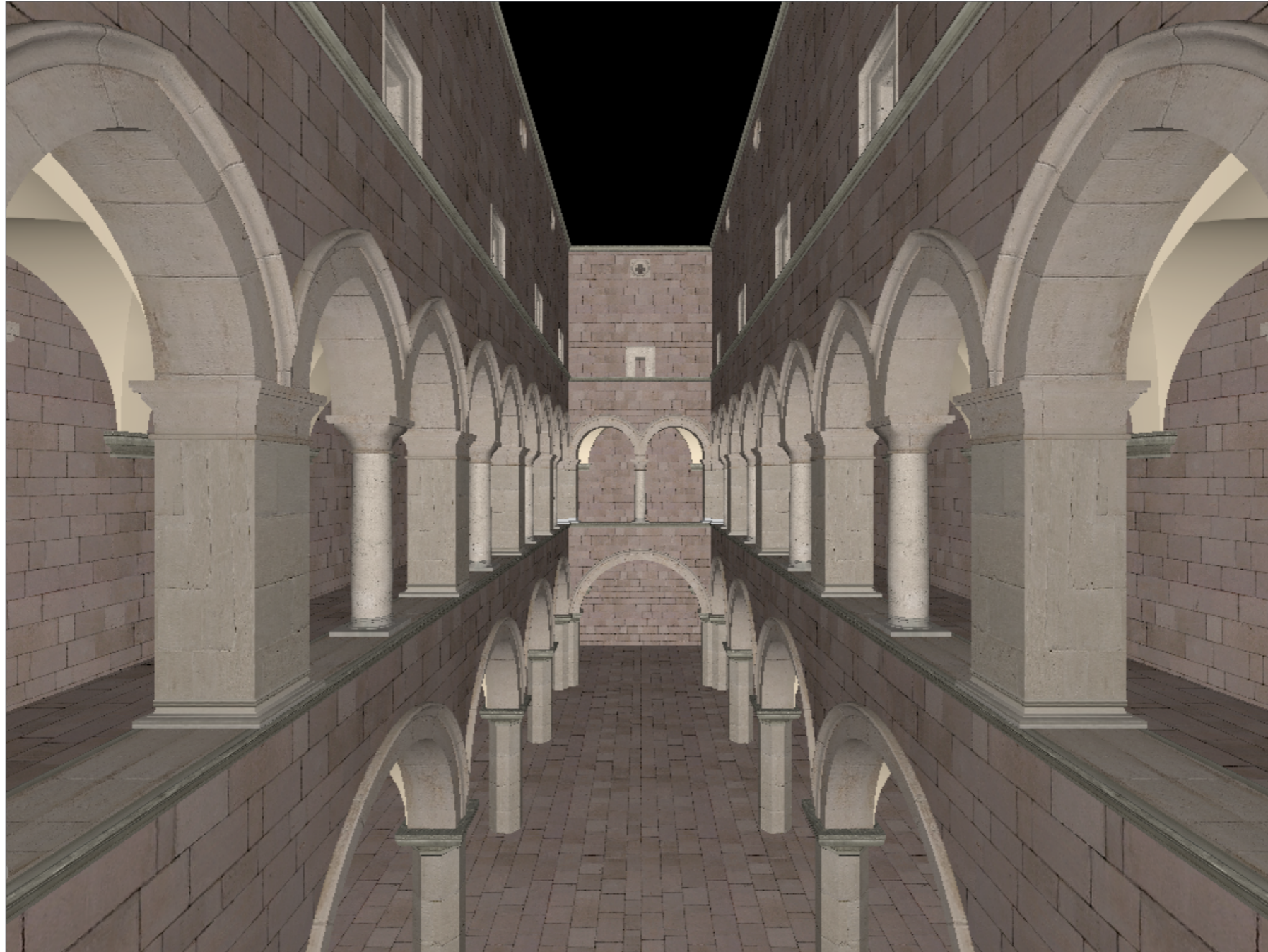

Visualization of texture coordinates

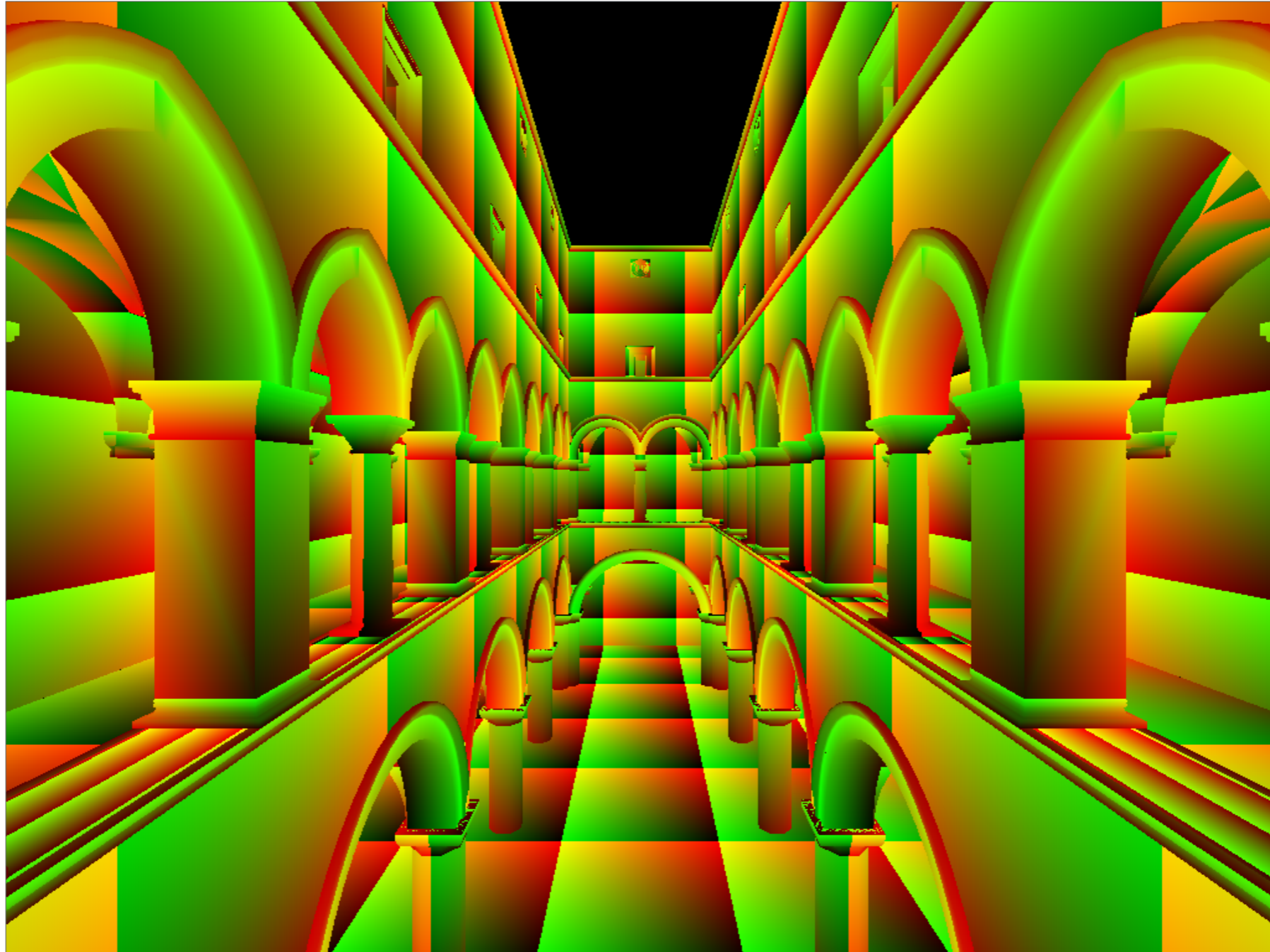

Textures can be used multiple times!

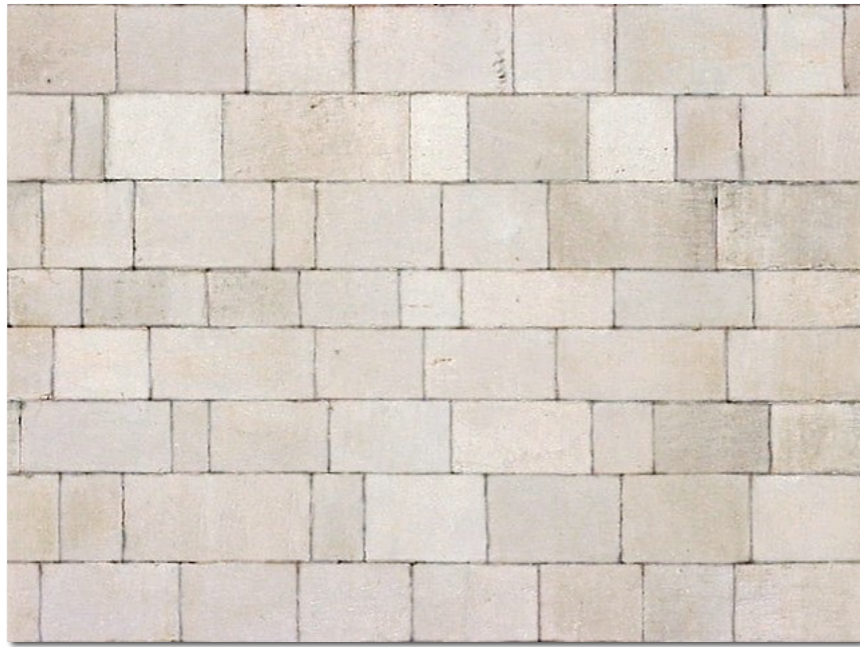

example textures
used / **tiled**

Thank you!

(And thank Prof. Ravi Ramamoorthi and Prof. Ren Ng for many of the slides!)