

Introduction to Computer Graphics

GAMES101, Lingqi Yan, UC Santa Barbara

Lecture 19: Cameras, Lenses and Light Fields

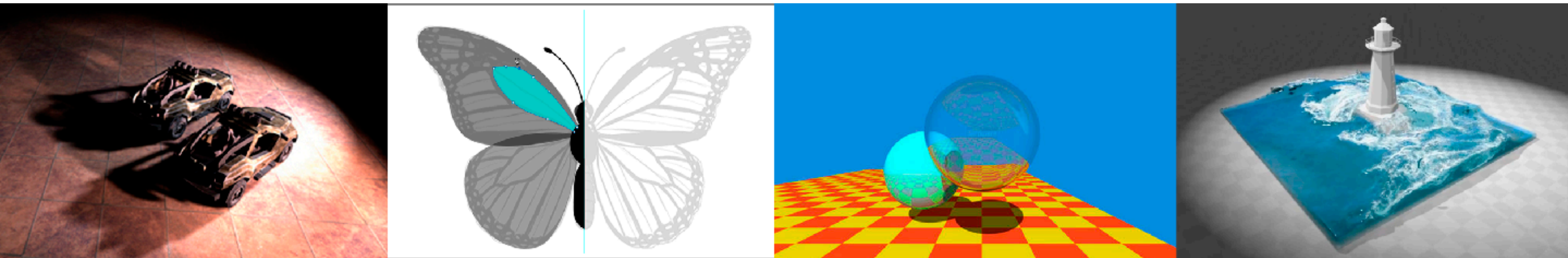

Announcements

- Standalone topics this week
 - No related homework for lectures in this week
- Final project ideas will be released soon
 - Note: submit your (very short) proposal on/before Apr 19, if you want to do something else (encouraged)



Imaging = Synthesis + Capture

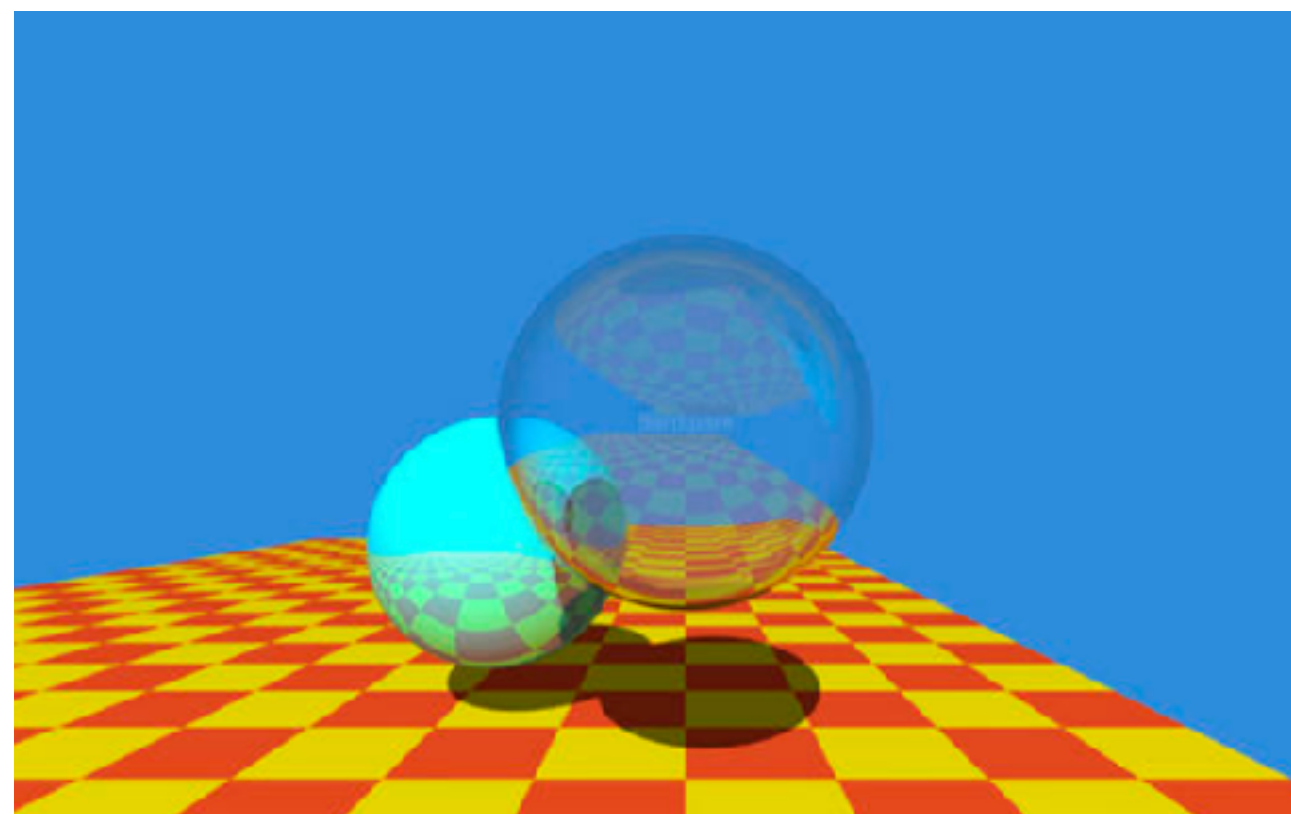

What's Happening Inside the Camera?

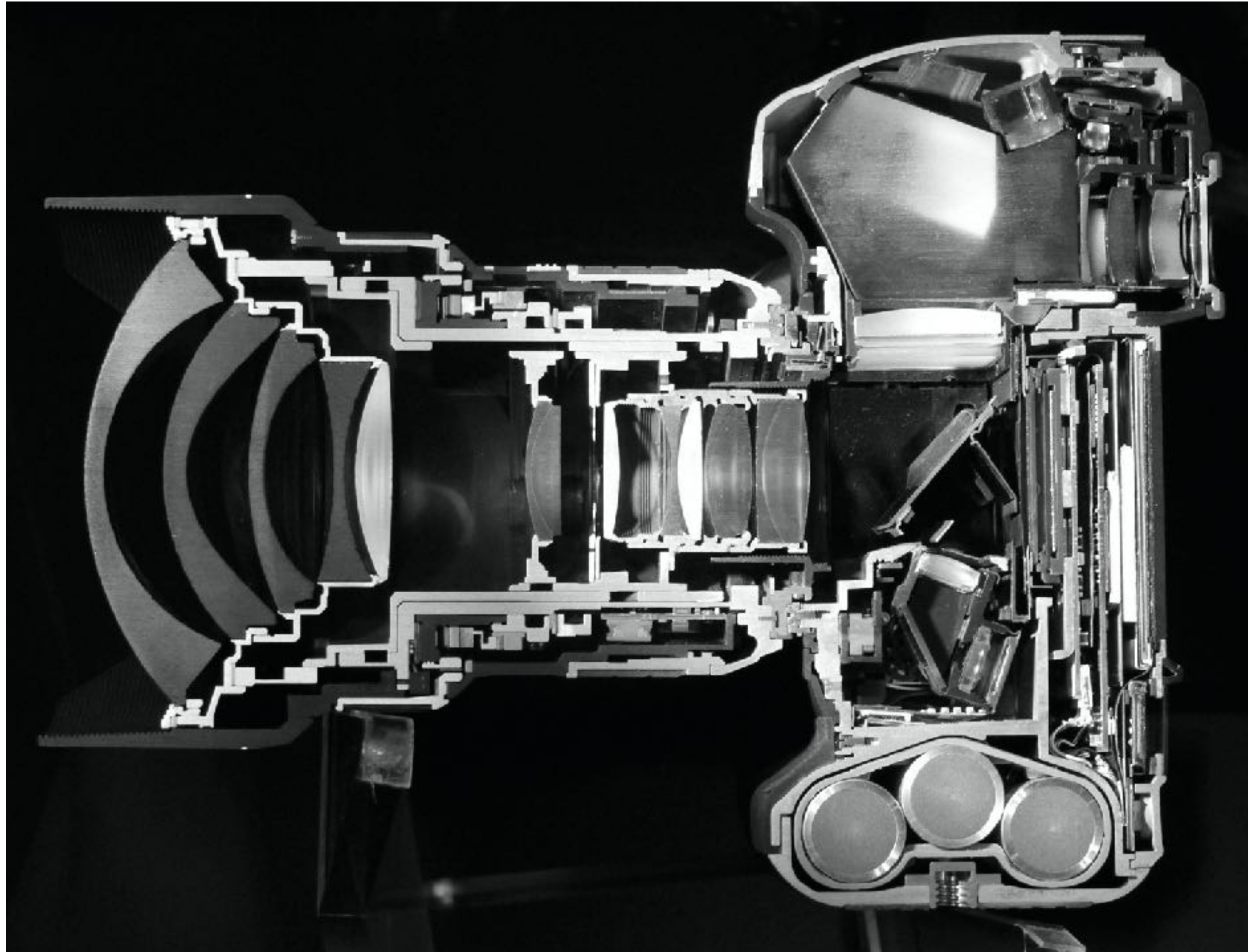

Cross-section of Nikon D3, 14-24mm F2.8 lens

Pinholes & Lenses Form Image on Sensor

(传感器)

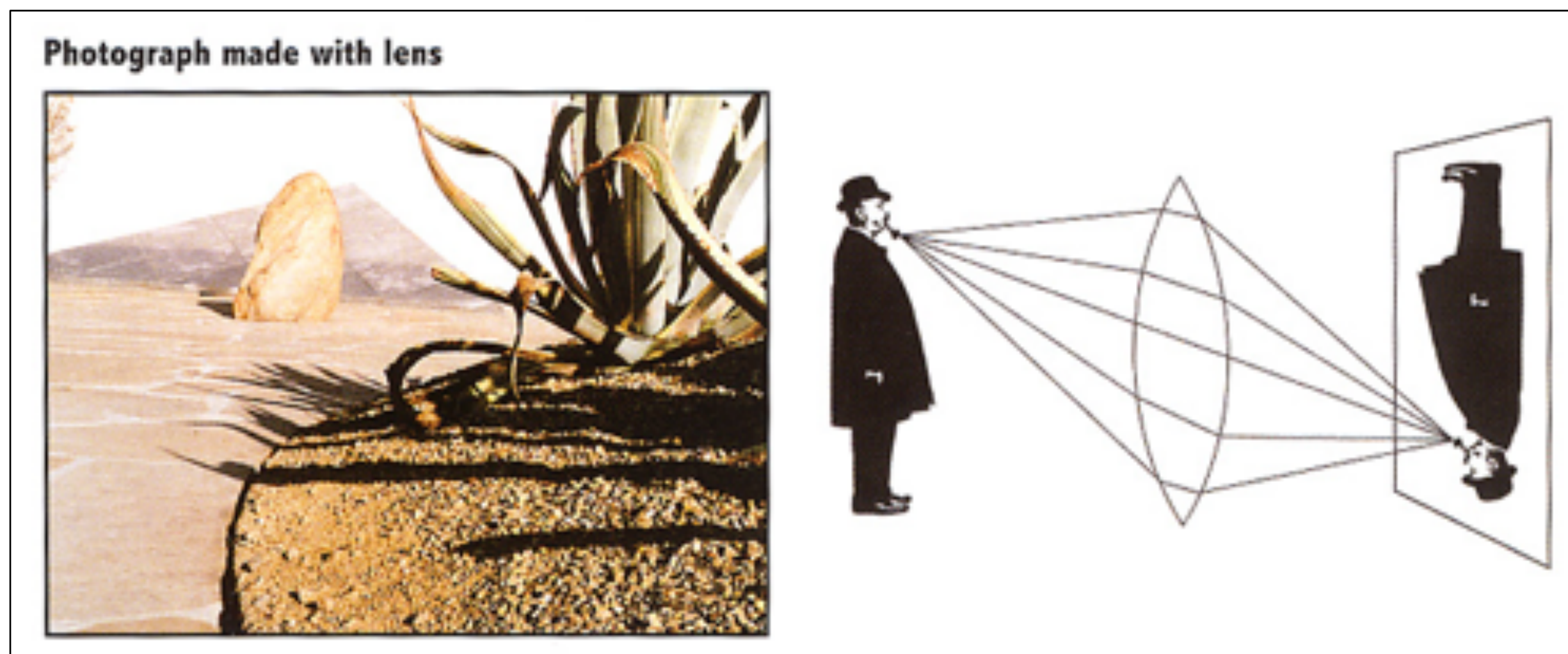
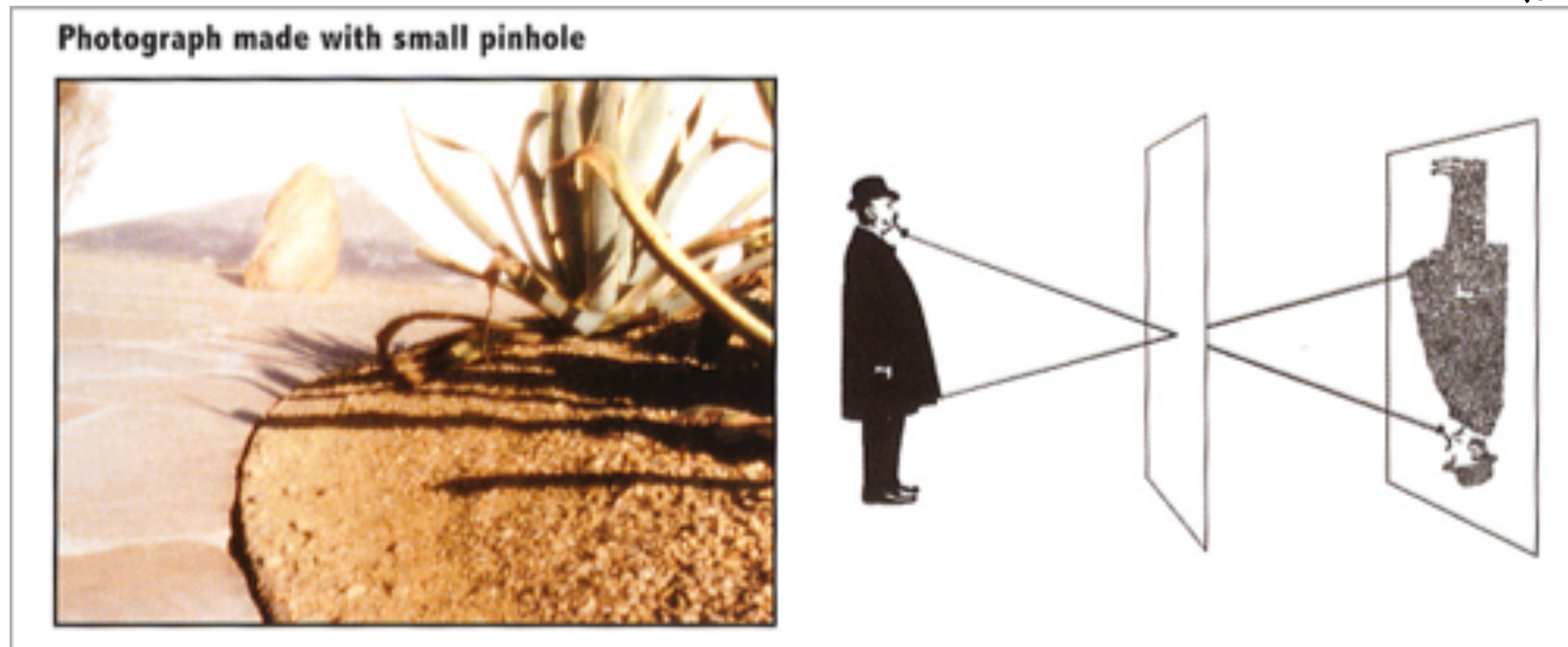

London and Upton

Shutter Exposes Sensor For Precise Duration

(快门)

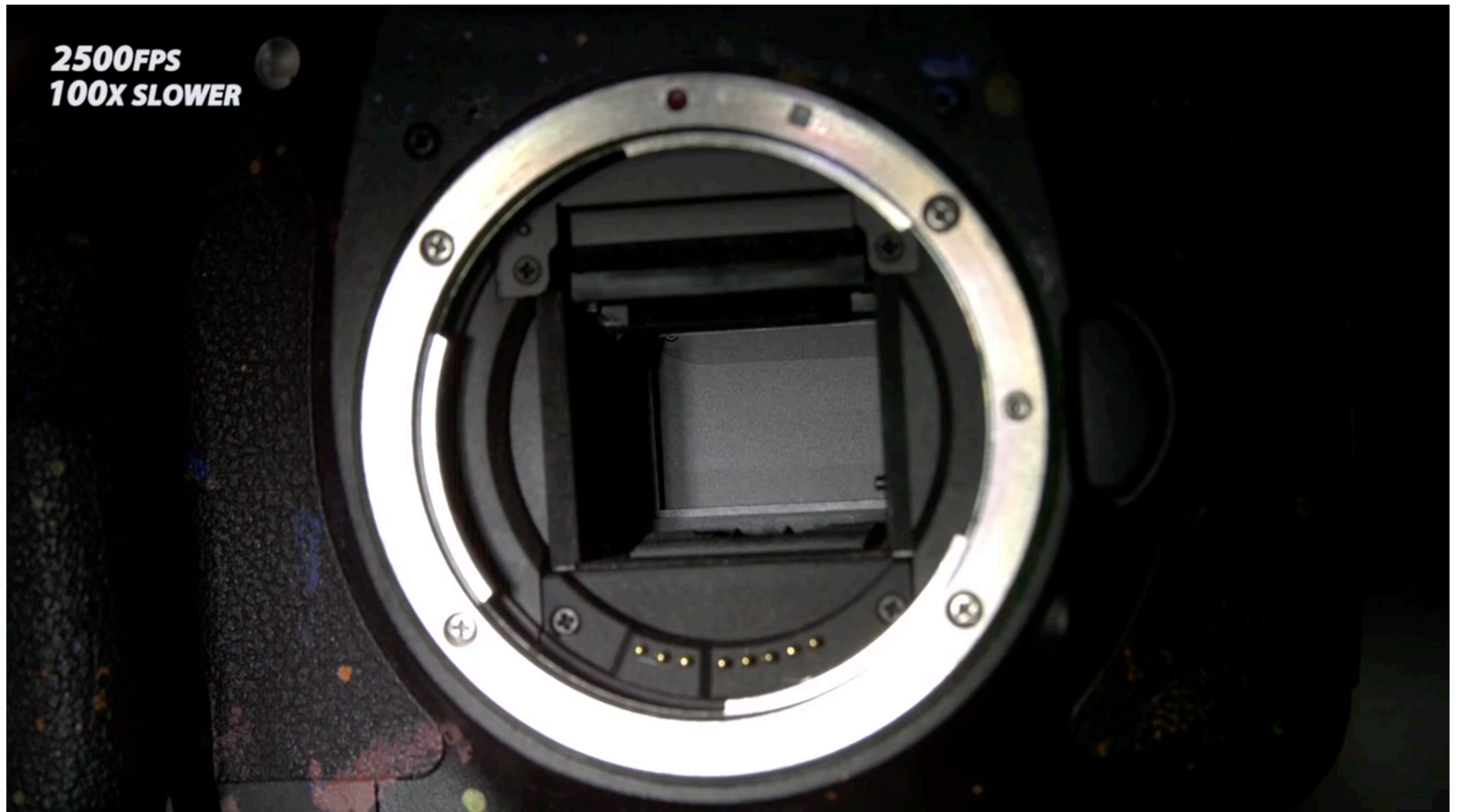

The Slow Mo Guys, <https://youtu.be/CmjeCchGRQo>

Sensor Accumulates Irradiance During Exposure

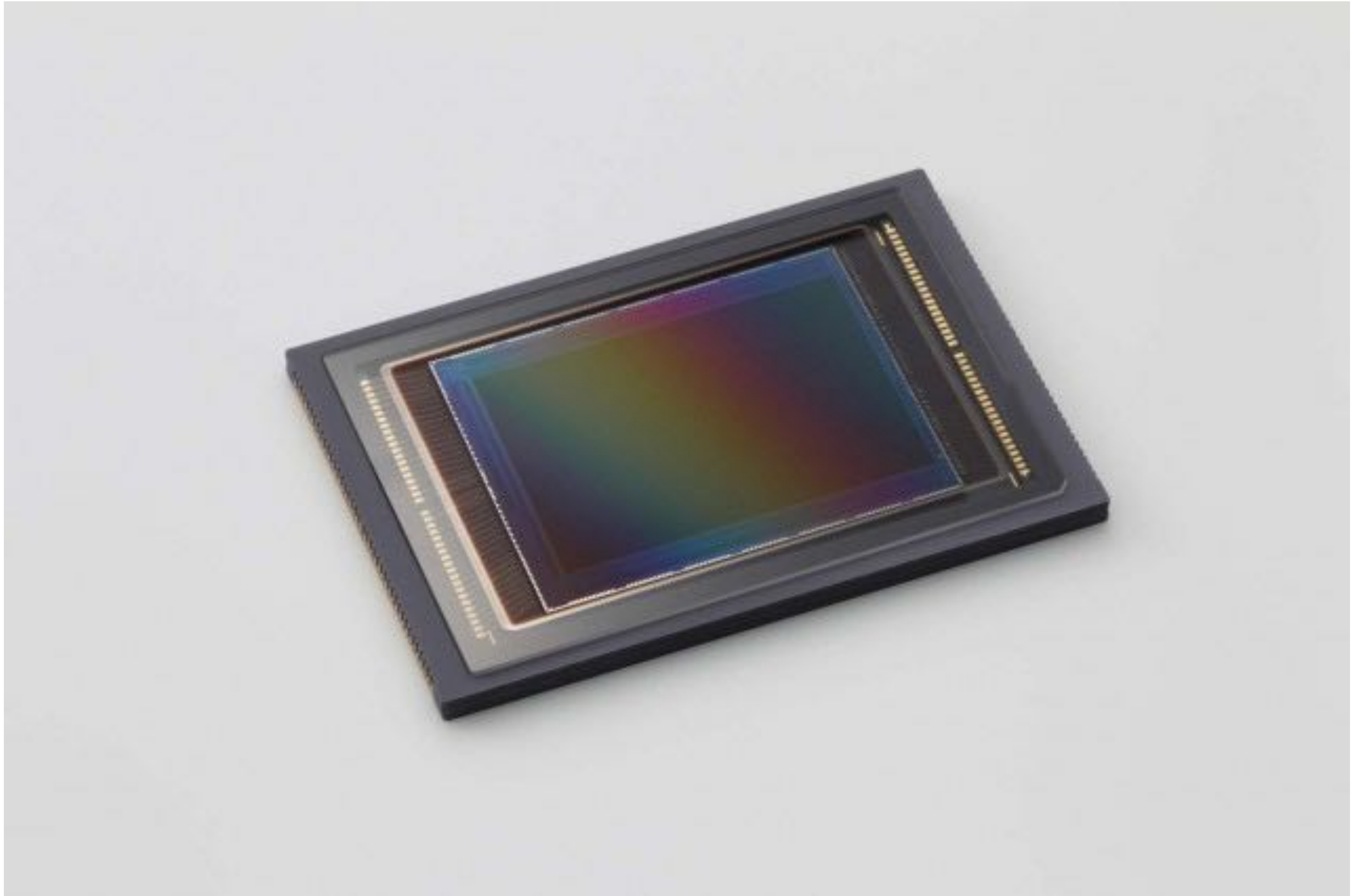

Why Not Sensors Without Lenses?

Each sensor point would integrate light from all points on the object, so all pixel values would be similar
i.e. the sensor records **irradiance**

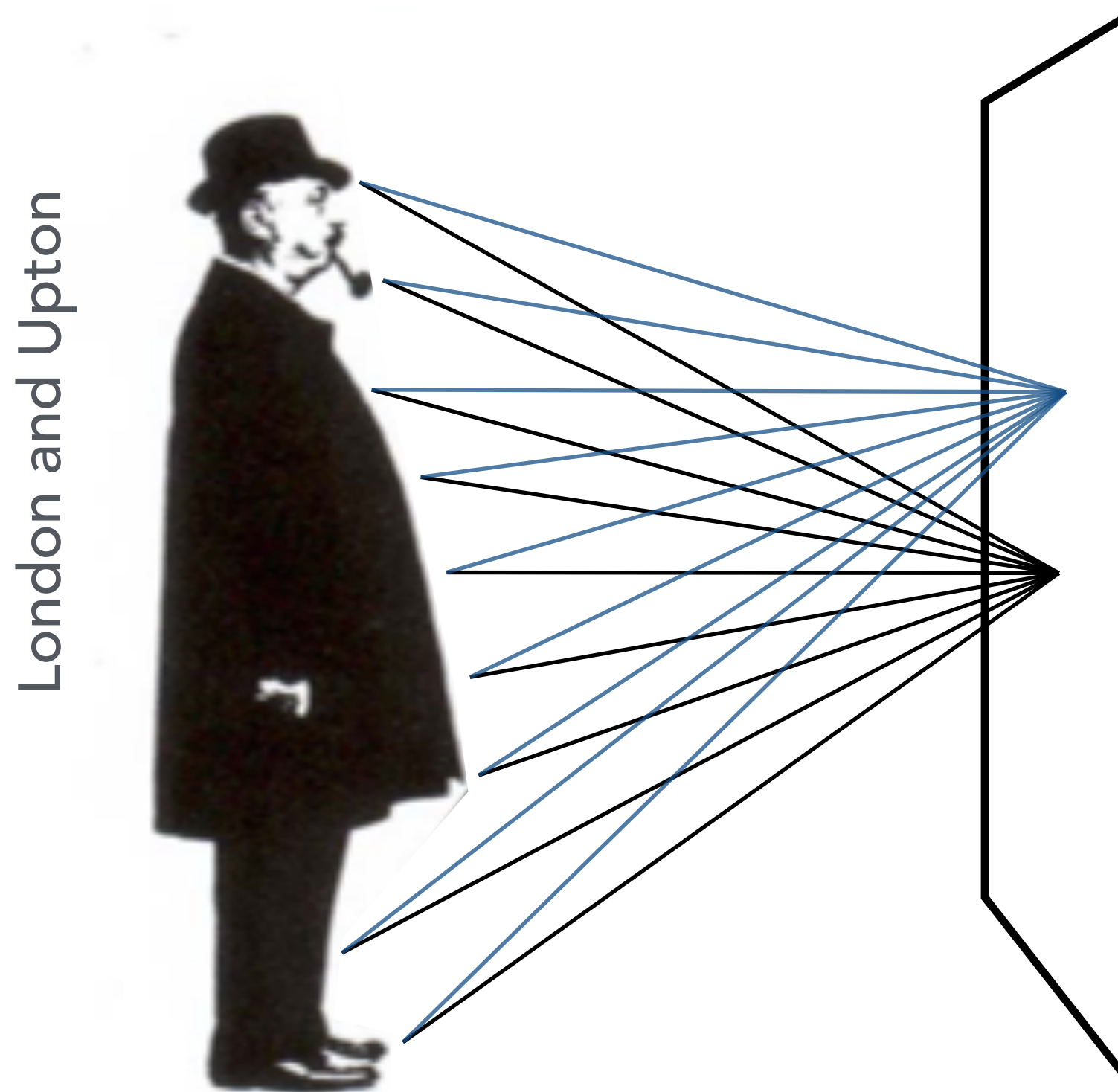

but there is computational imaging research...

Pinhole Image Formation

Pinhole Camera

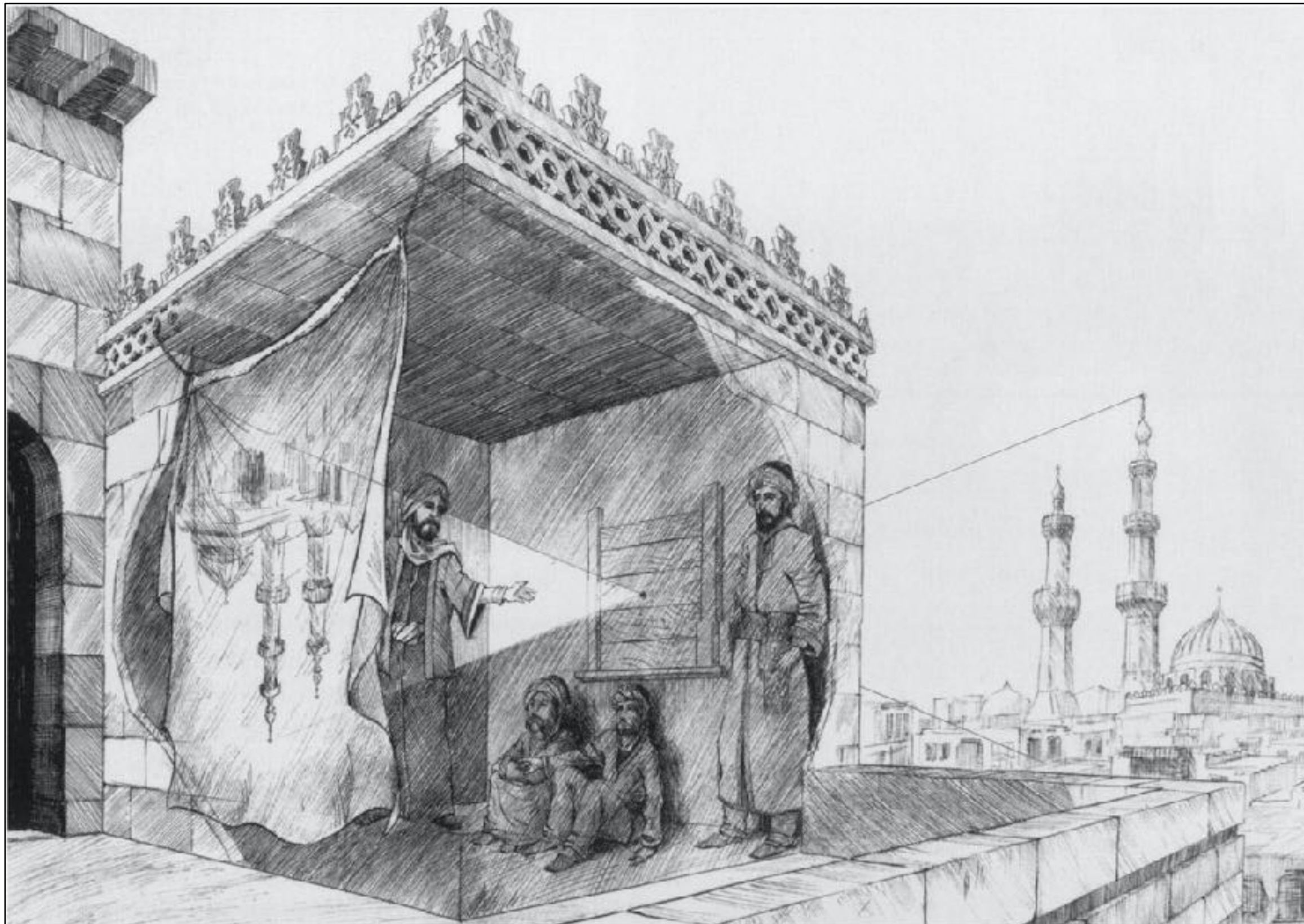

Mo Tzu (c. 470–c. 390 BC)

Aristotle (384–322 BC)

Ibn al-Haytham (965–1040)

Shen Kuo (1031–1095)

Roger Bacon (c. 1214–1294)

Johannes Kepler (1571–1630)

A. H. Zewail, *Phil. Trans. R. Soc. A* 2010;368:1191-1204

Largest Pinhole Photograph

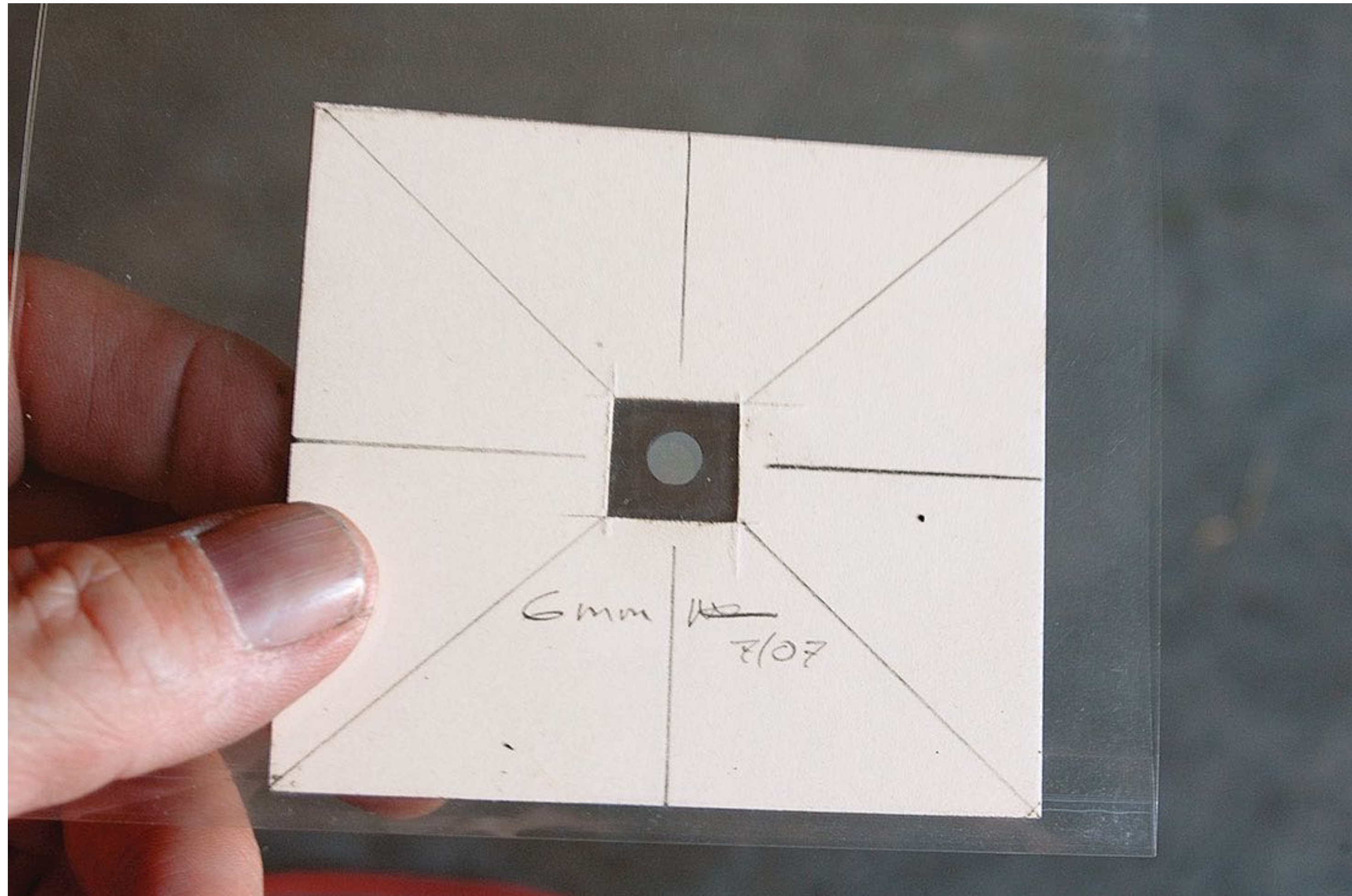

legacyphotoproject.com

Largest Pinhole Photograph



legacyphotoproject.com

Field of View (FOV)

(视场)

Effect of Focal Length on FOV

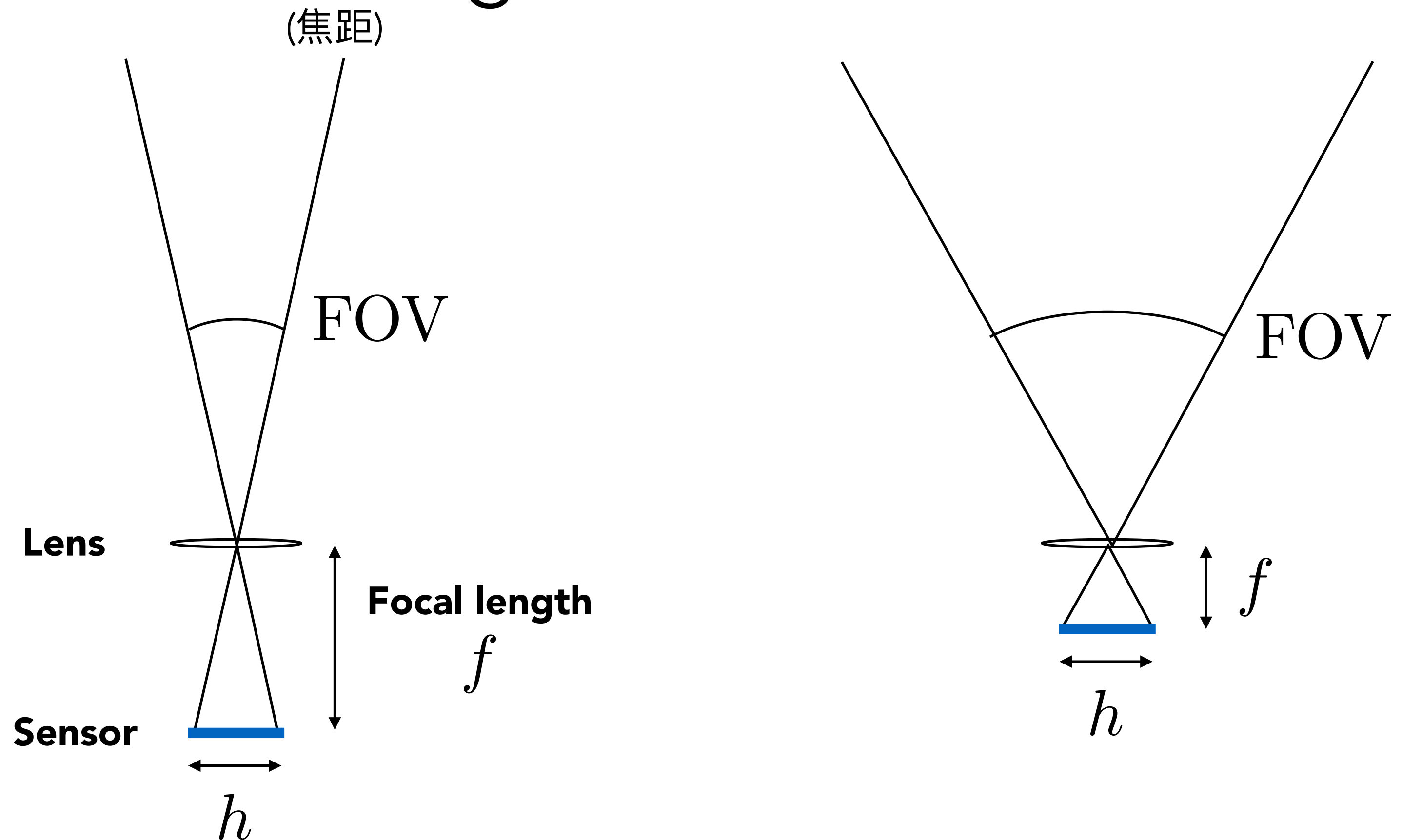

For a fixed sensor size, decreasing the focal length increases the field of view.

$$\text{FOV} = 2 \arctan \left(\frac{h}{2f} \right)$$

Focal Length v. Field of View

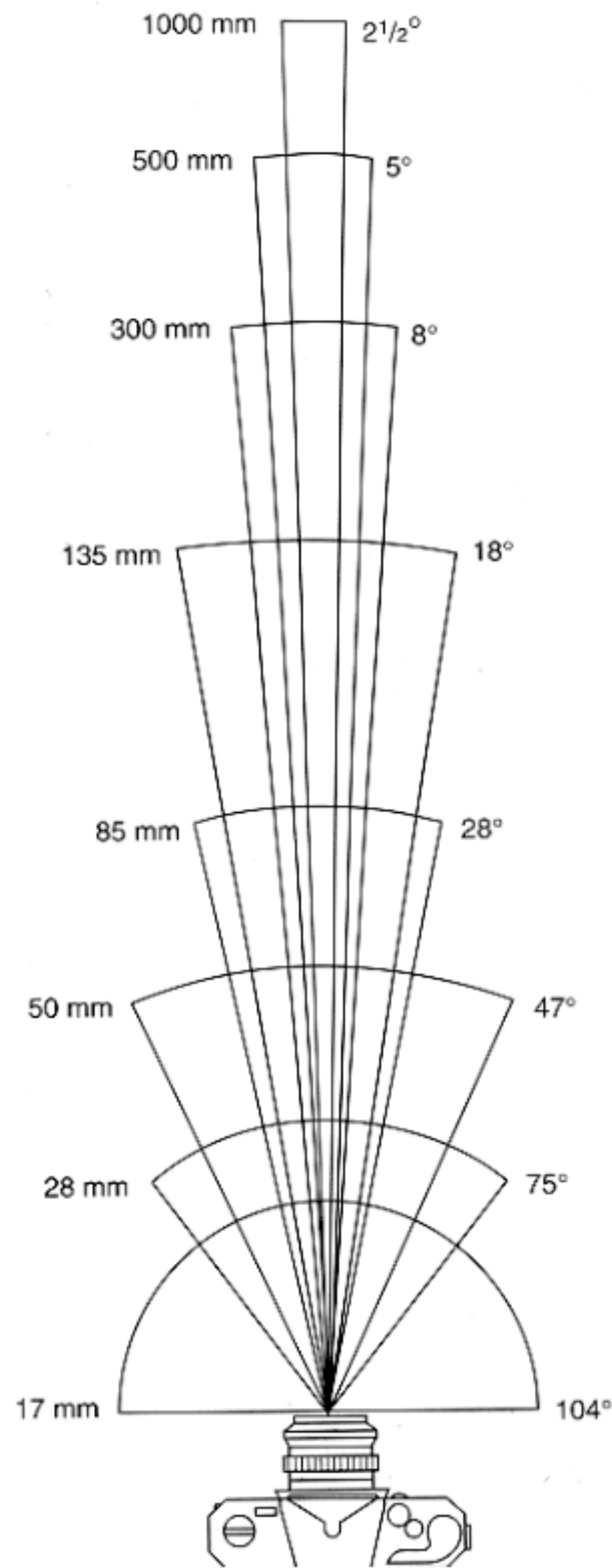

- For historical reasons, it is common to refer to angular field of view by focal length of a lens used on a 35mm-format film (36 x 24mm)
- Examples of focal lengths on 35mm format:
 - 17mm is wide angle 104°
 - 50mm is a "normal" lens 47°
 - 200mm is telephoto lens 12°
- Careful! When we say current cell phones have approximately 28mm "equivalent" focal length, this uses the above convention.

Focal Length v. Field of View

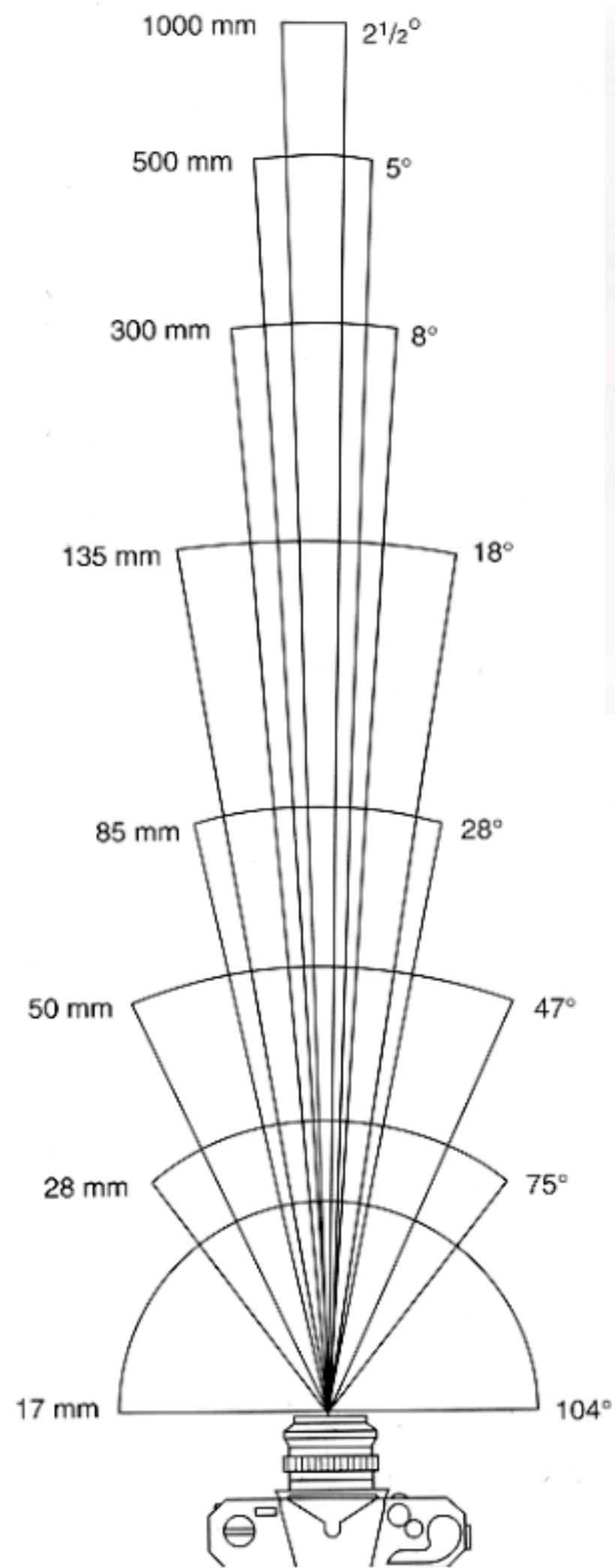

From London and Upton, and Canon EF Lens Work III

Effect of Sensor Size on FOV

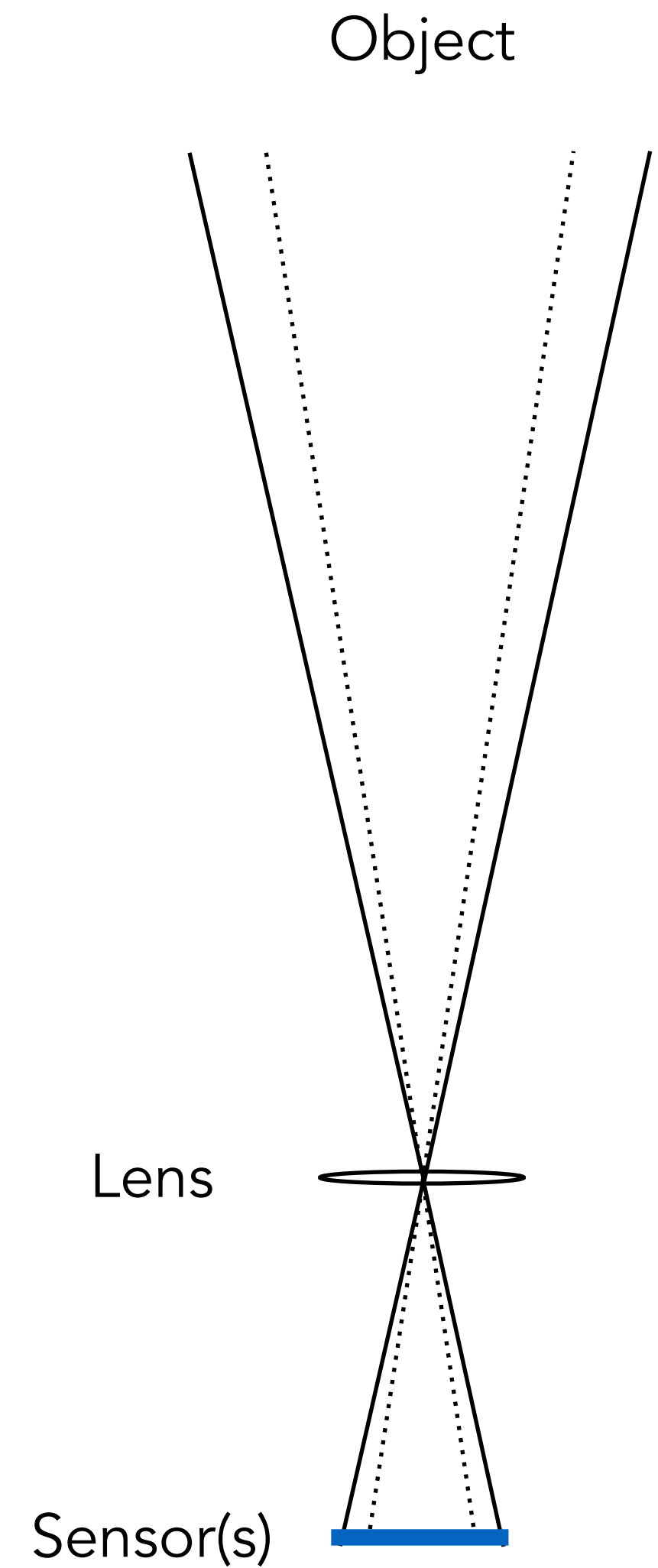
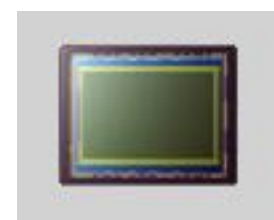
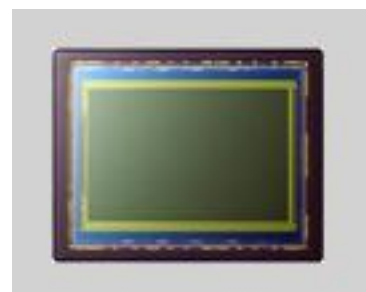
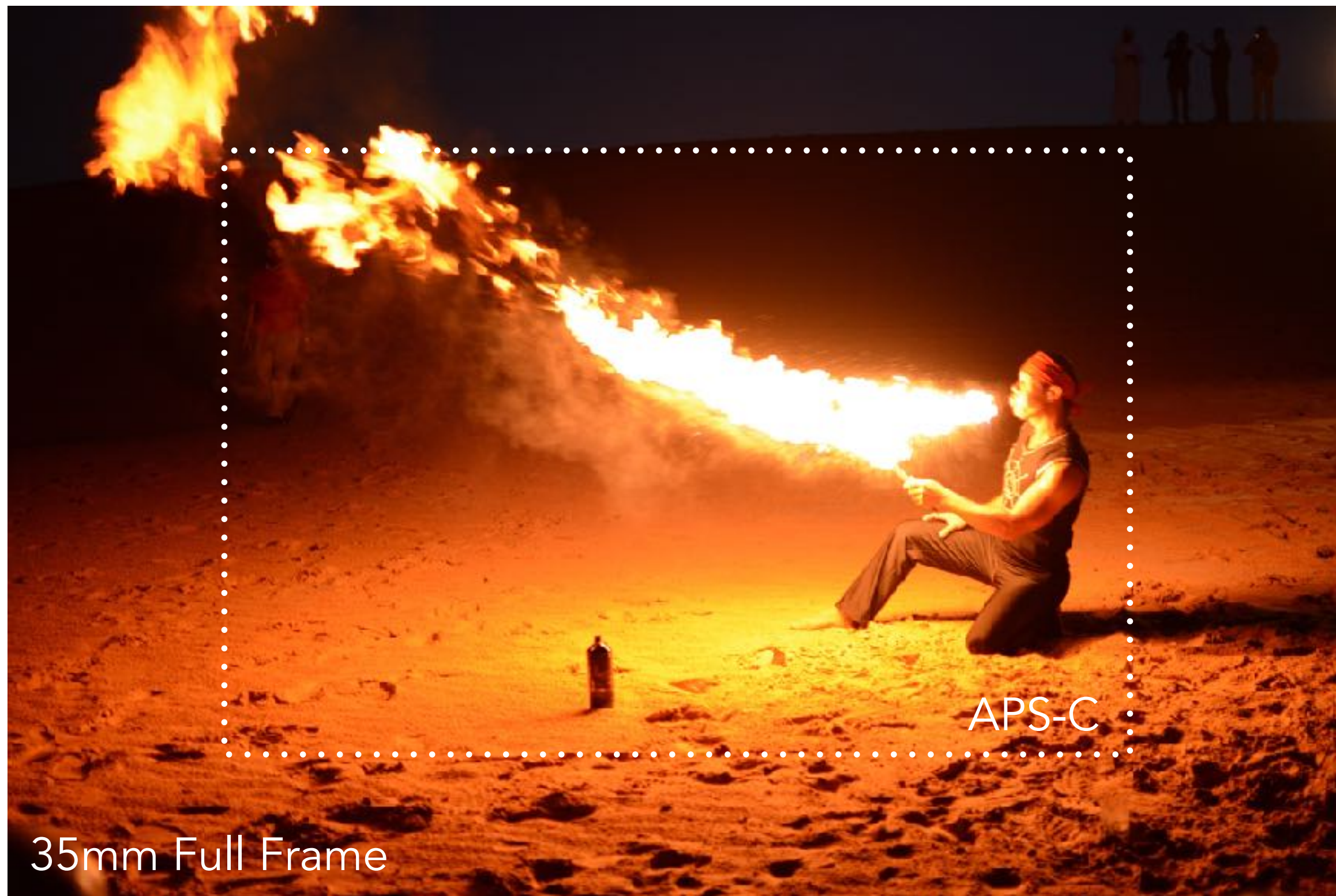

Sensor Sizes

Sensor Name	Medium Format	Full Frame	APS-H	APS-C	4/3	1"	1/1.63"	1/2.3"	1/3.2"
Sensor Size	53.7 x 40.2mm	36 x 23.9mm	27.9x18.6mm	23.6x15.8mm	17.3x13mm	13.2x8.8mm	8.38x5.59mm	6.16x4.62mm	4.54x3.42mm
Sensor Area	21.59 cm ²	8.6 cm ²	5.19 cm ²	3.73 cm ²	2.25 cm ²	1.16 cm ²	0.47 cm ²	0.28 cm ²	0.15 cm ²
Crop Factor	0.64	1.0	1.29	1.52	2.0	2.7	4.3	5.62	7.61
Image									
Example									



Credit: lensvid.com

Maintain FOV on Smaller Sensor?

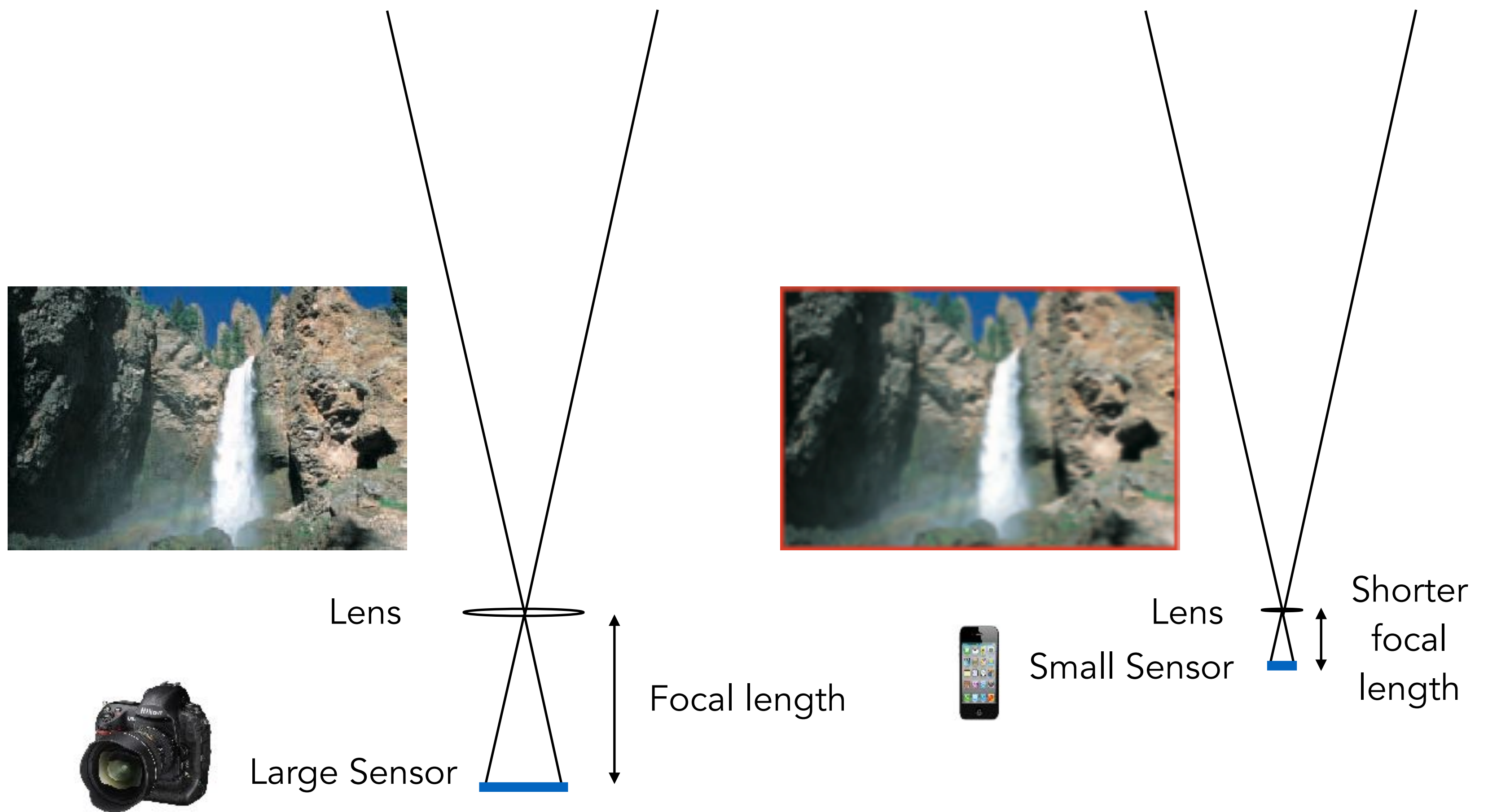

To maintain FOV, decrease focal length of lens in proportion to width/height of sensor

Exposure

Exposure

- $H = T \times E$
- Exposure = time x irradiance
- Exposure time (T)
 - Controlled by shutter
- Irradiance (E)
 - Power of light falling on a unit area of sensor
 - Controlled by lens aperture and focal length

Exposure Controls in Photography

Aperture size

- Change the f-stop by opening / closing the aperture (if camera has iris control)

Shutter speed

- Change the duration the sensor pixels integrate light

ISO gain (感光度)

- Change the amplification (analog and/or digital) between sensor values and digital image values

Exposure: Aperture, Shutter, Gain (ISO)

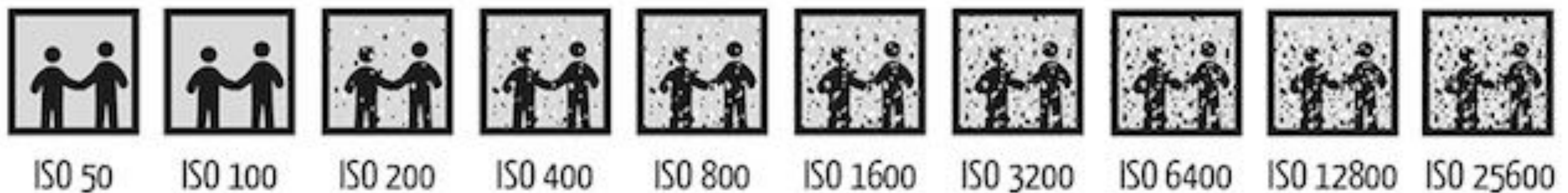
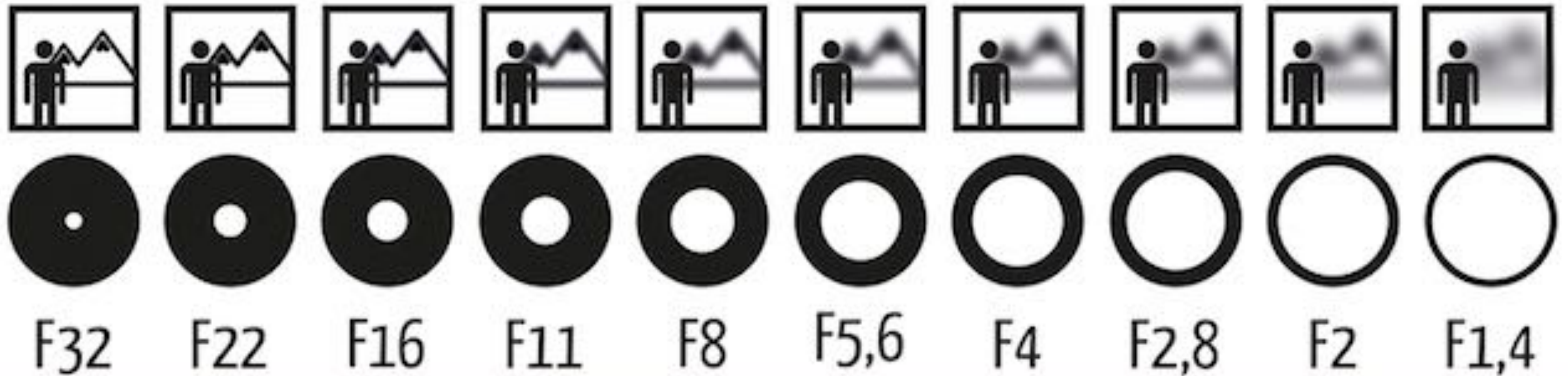

Photoblog Hamburg

ISO (Gain)

Third variable for exposure

Film: trade sensitivity for grain

Digital: trade sensitivity for noise

- Multiply signal before analog-to-digital conversion
- Linear effect (ISO 200 needs half the light as ISO 100)

ISO Gain vs Noise in Canon T2i

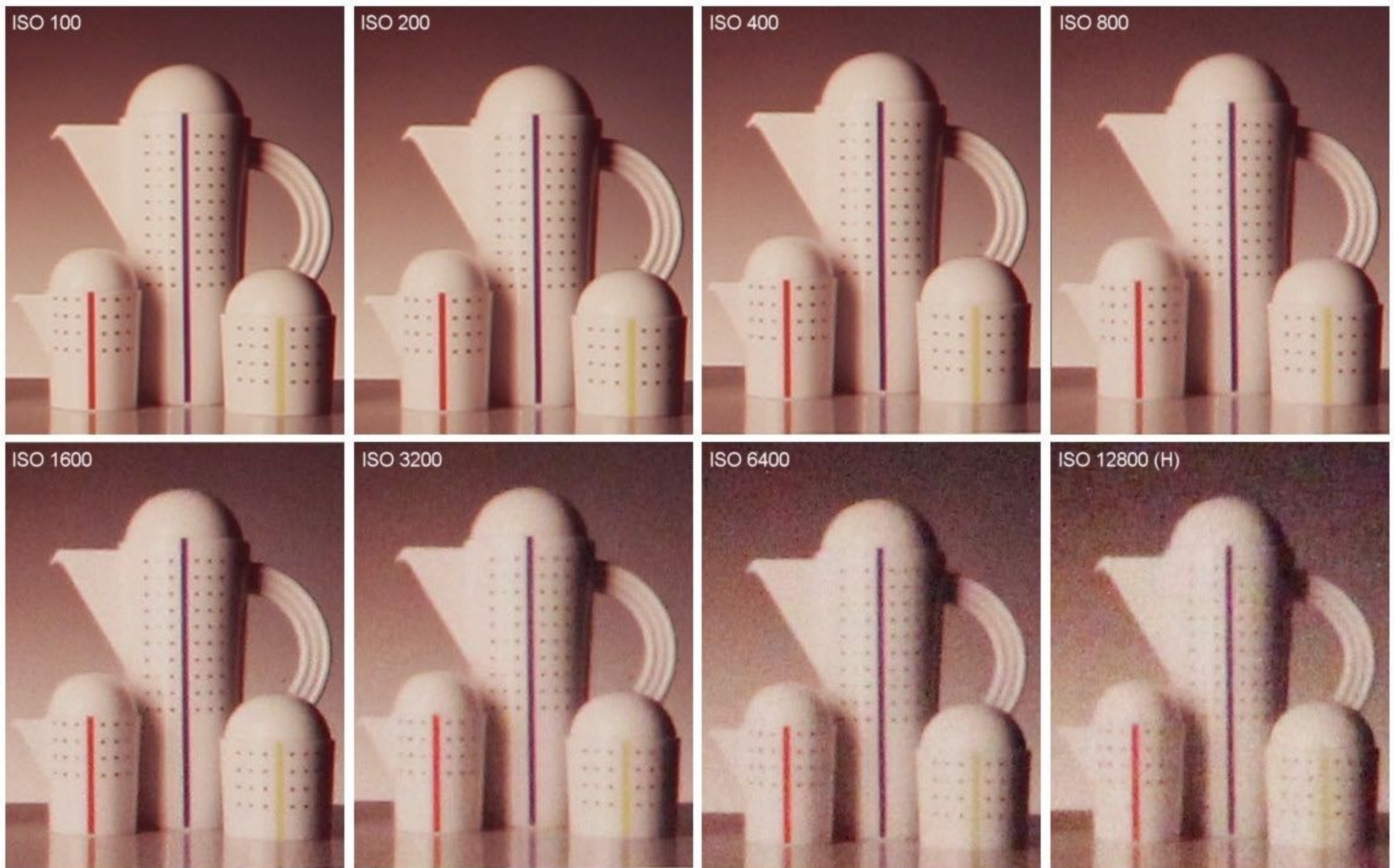

Credit: bobatkings.com

F-Number (F-Stop): Exposure Levels

Written as FN or F/N . N is the f-number.

Informal understanding: the inverse-diameter of a round aperture



<https://www.dpmag.com/how-to/tip-of-the-week/how-and-why-to-use-auto-exposure-bracketing/>

Physical Shutter (1/25 Sec Exposure)

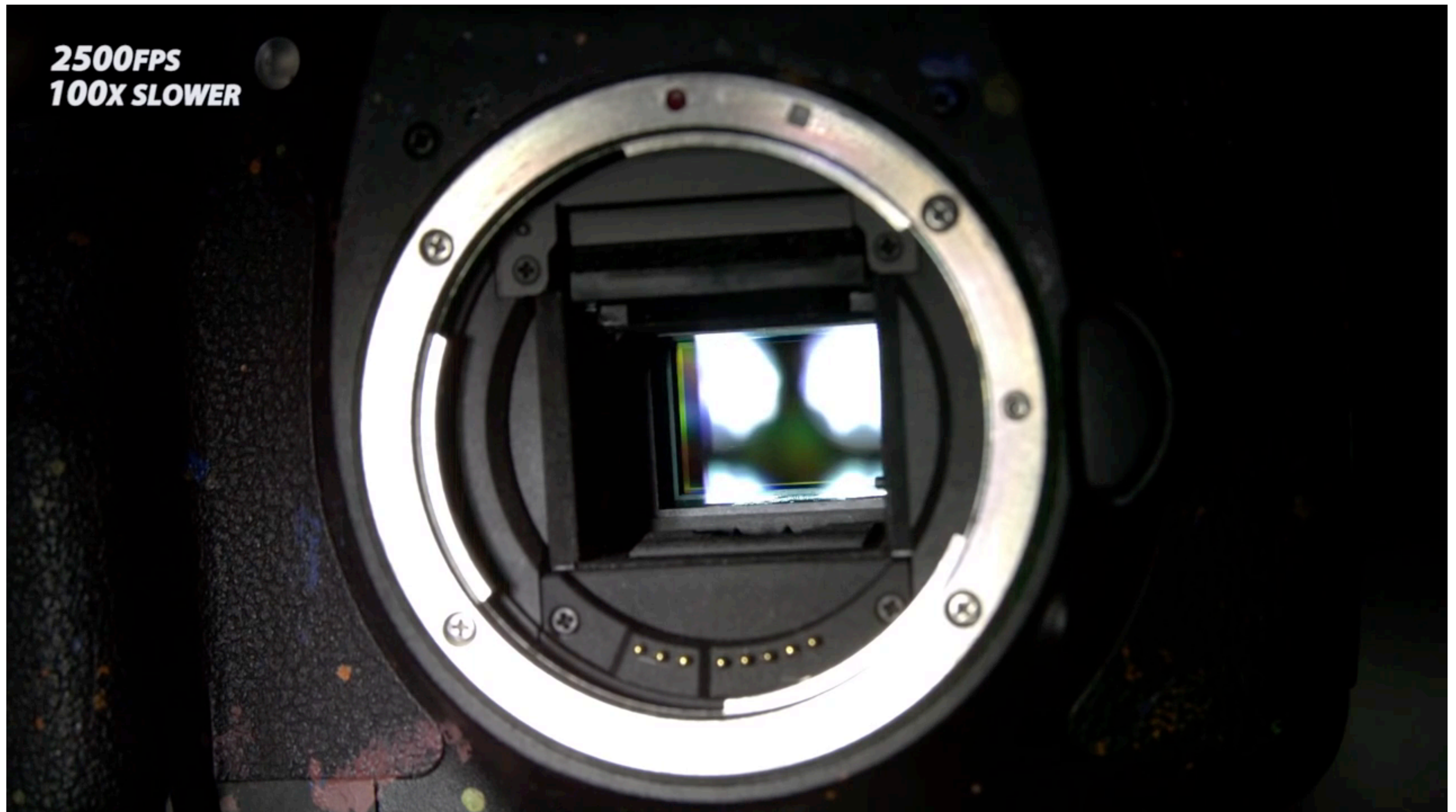

The Slow Mo Guys, <https://youtu.be/CmjeCchGRQo>

Side Effect of Shutter Speed

Motion blur: handshake, subject movement

Doubling shutter time doubles motion blur



<http://www.gavtrain.com/?p=3960>

Gavin Hoey

Side Effect of Shutter Speed

Note: motion blur is not always bad!

Tip: think about anti-aliasing

Slow shutter speed



Fast shutter speed



London

Side Effect of Shutter Speed

Rolling shutter: different parts of photo taken at different times



<https://www.premiumbeat.com/blog/3-tips-for-dealing-with-rolling-shutter/>

Constant Exposure: F-Stop vs Shutter Speed

Example: these pairs of aperture and shutter speed give equivalent exposure

F-Stop	1.4	2.0	2.8	4.0	5.6	8.0	11.0	16.0	22.0	32.0
Shutter	1/500	1/250	1/125	1/60	1/30	1/15	1/8	1/4	1/2	1

If the exposure is too bright/dark, may need to adjust f-stop and/or shutter up/down.

- Photographers must trade off depth of field (?) and motion blur for moving subjects (景深)

Fast and Slow Photography

High-Speed Photography

Normal exposure =
extremely fast shutter speed x
(large aperture and/or high ISO)

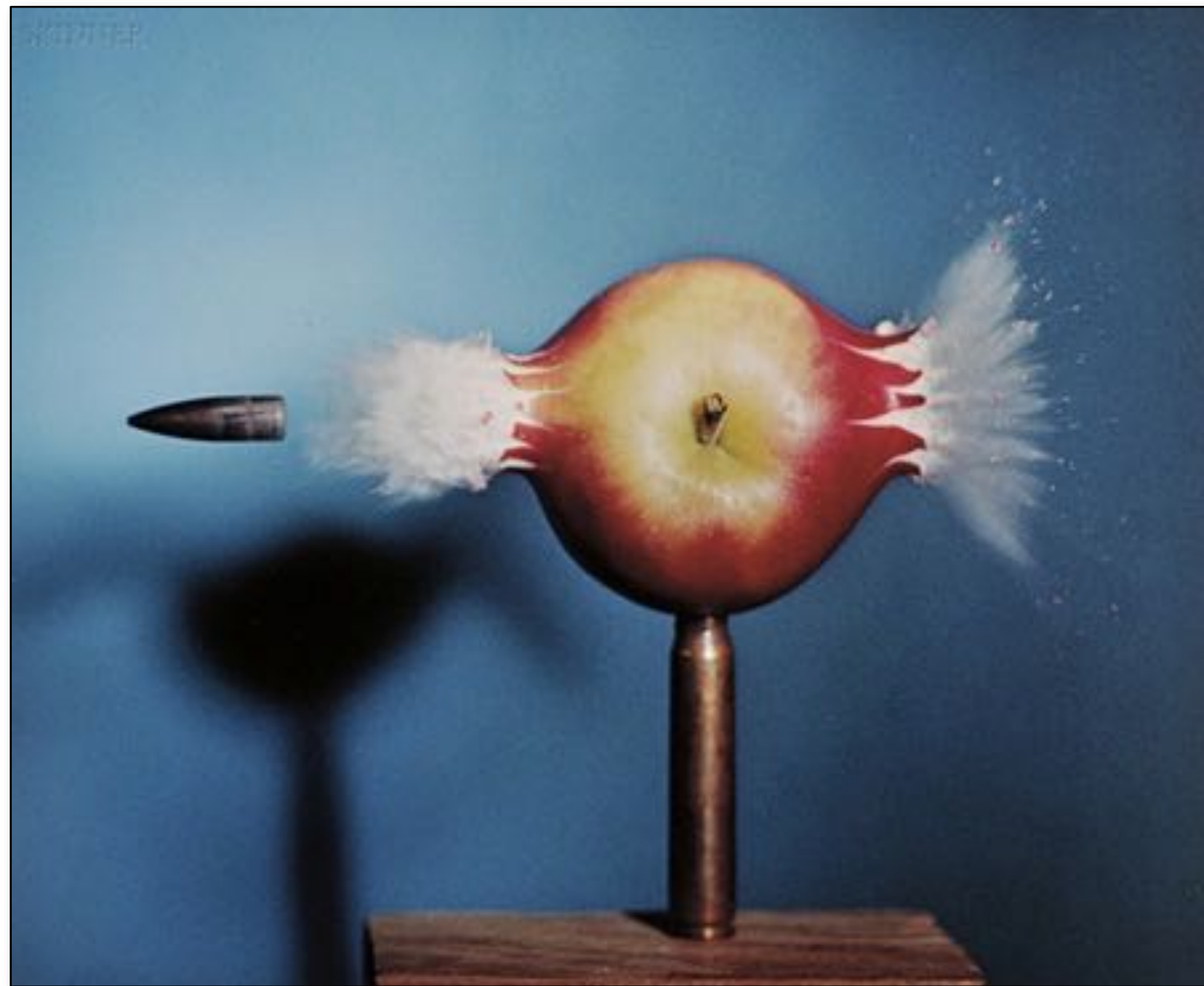

Harold Edgerton



Slide courtesy L. Waller

Mark Watson

High-Speed Photography

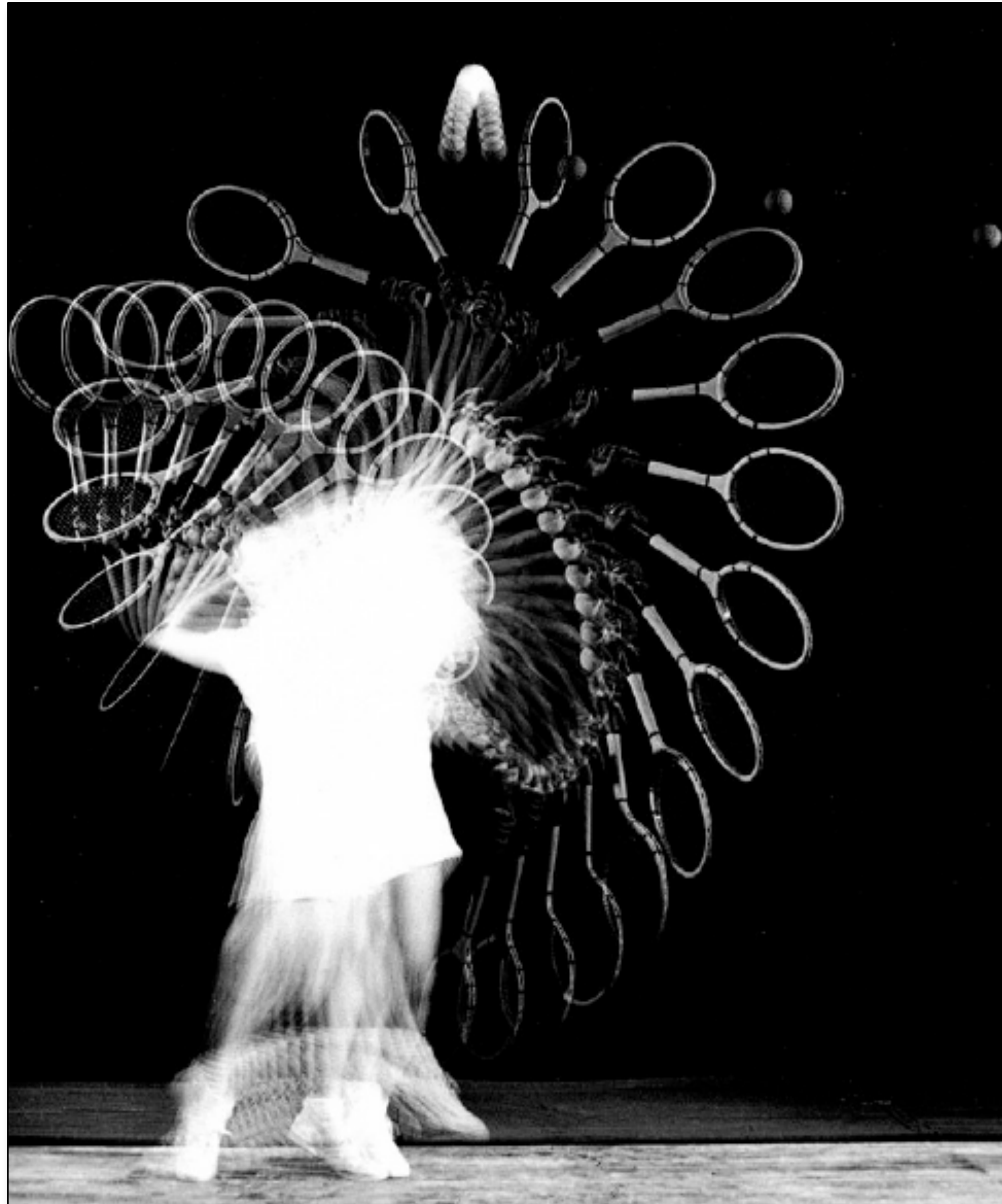

Long-Exposure Photography

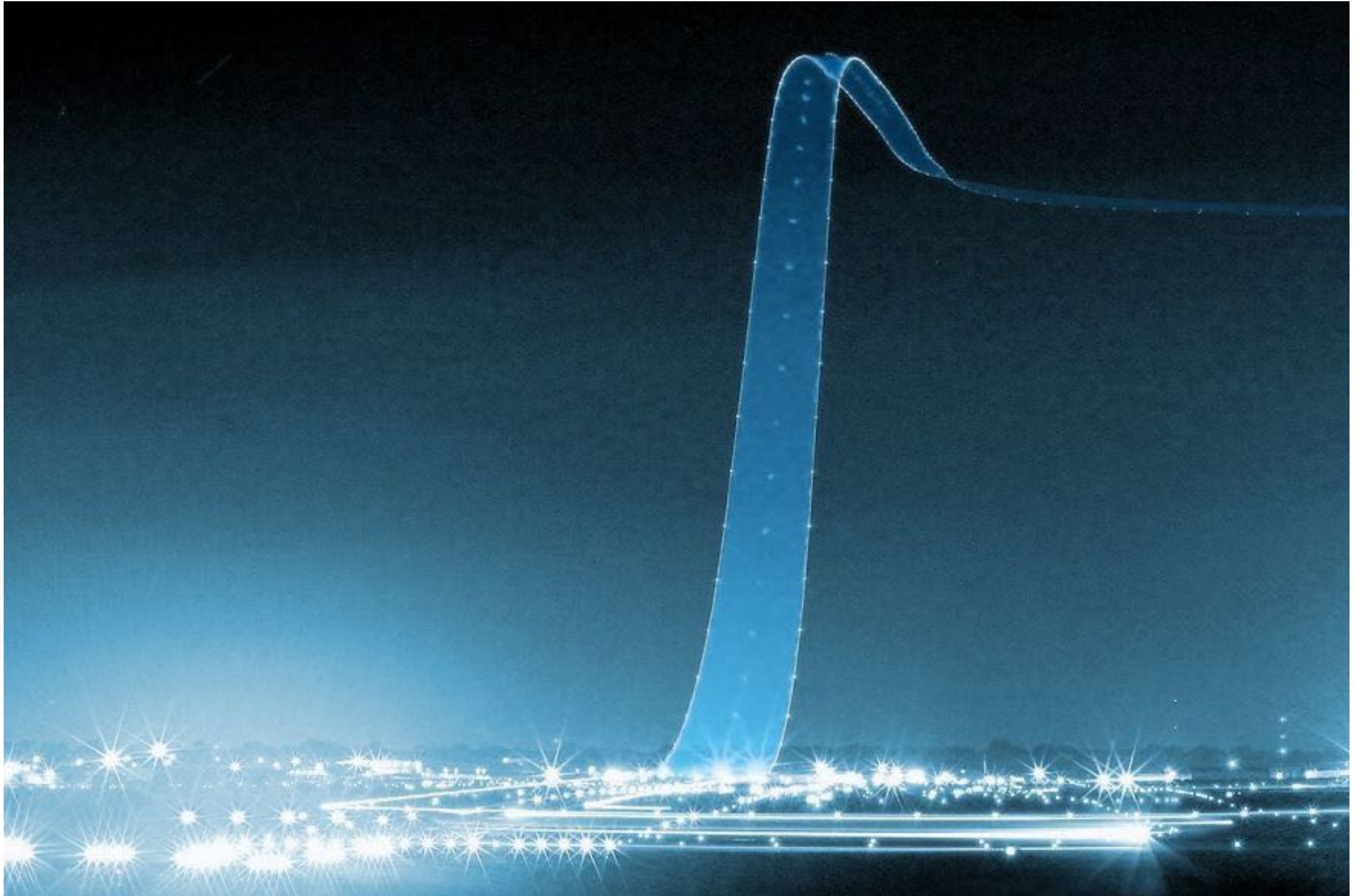

<https://www.demilked.com/best-long-exposure-photos/>

Long-Exposure Photography

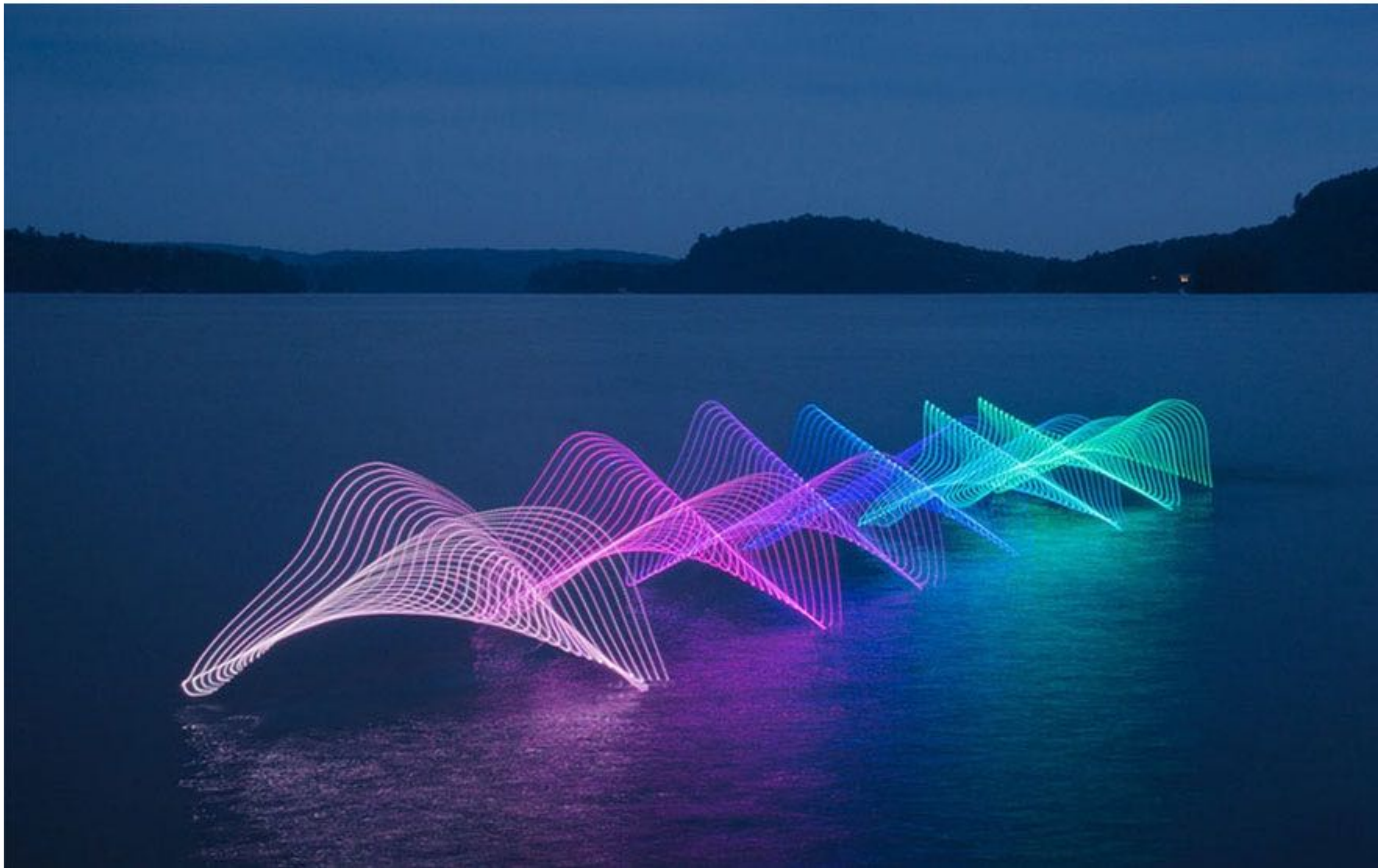

<https://www.demilked.com/best-long-exposure-photos/>

Long-Exposure Photography



<https://www.demilked.com/best-long-exposure-photos/>

Thin Lens Approximation

Real Lens Designs Are Highly Complex



[Apple]

Real Lens Elements Are Not Ideal – Aberrations

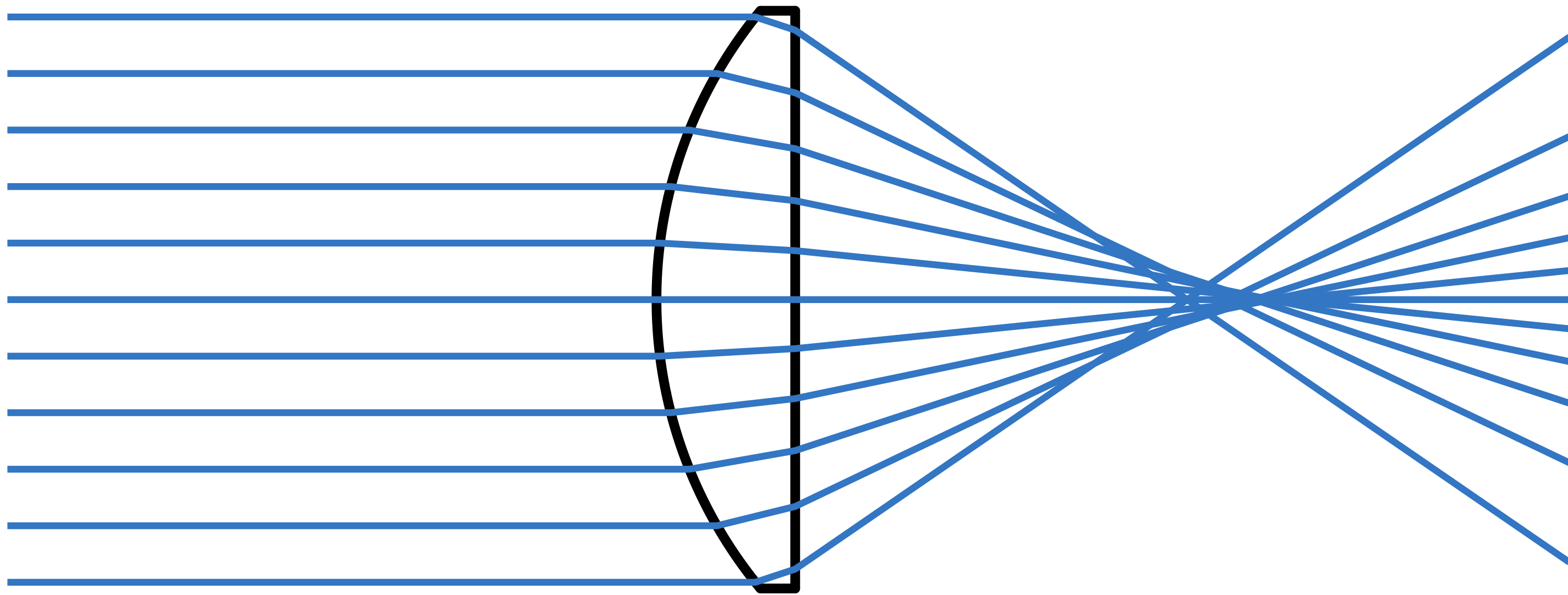

Real plano-convex lens (spherical surface shape).
Lens does not converge rays to a point anywhere.

Ideal Thin Lens – Focal Point

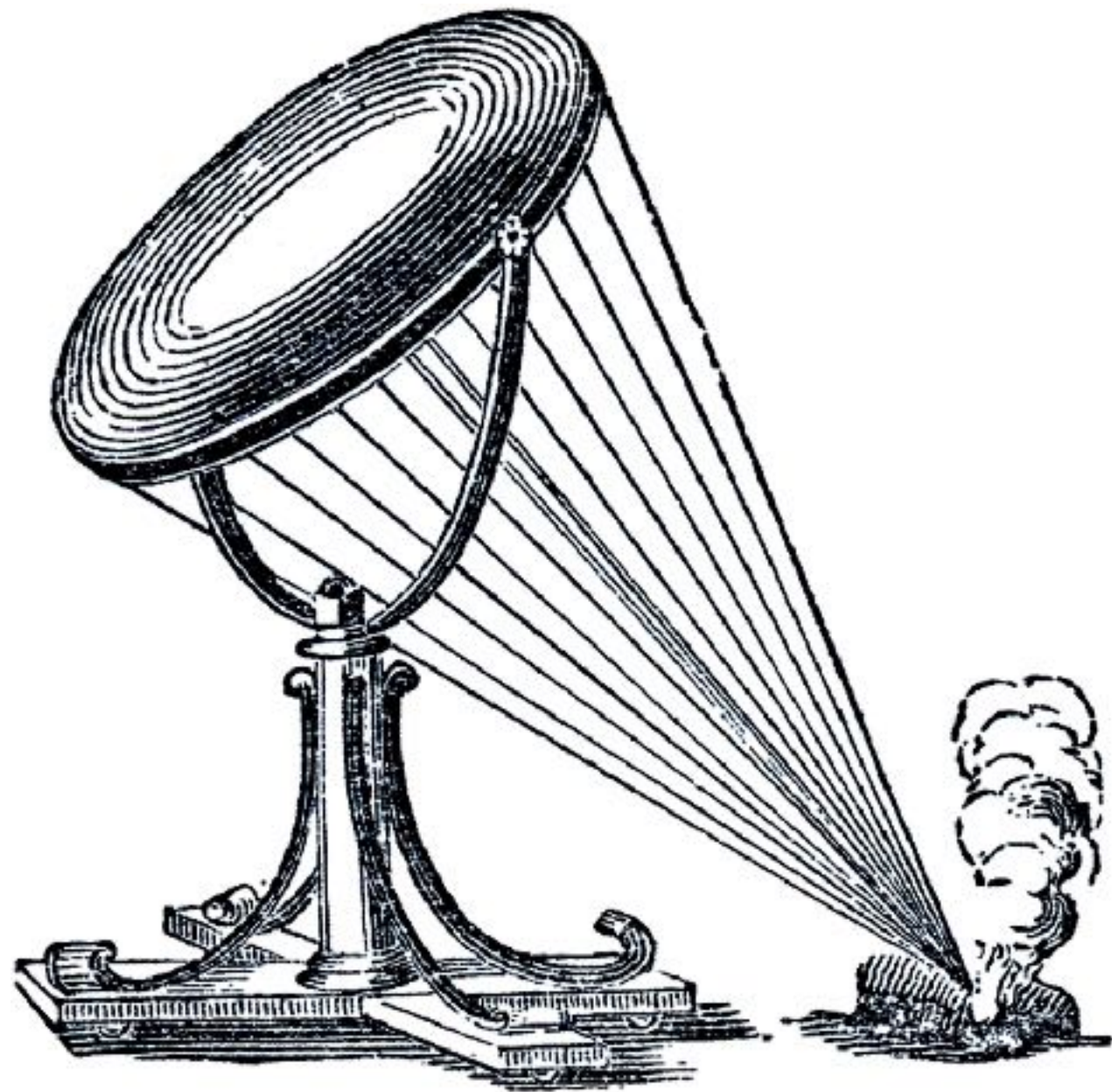

Credit: Karen Watson

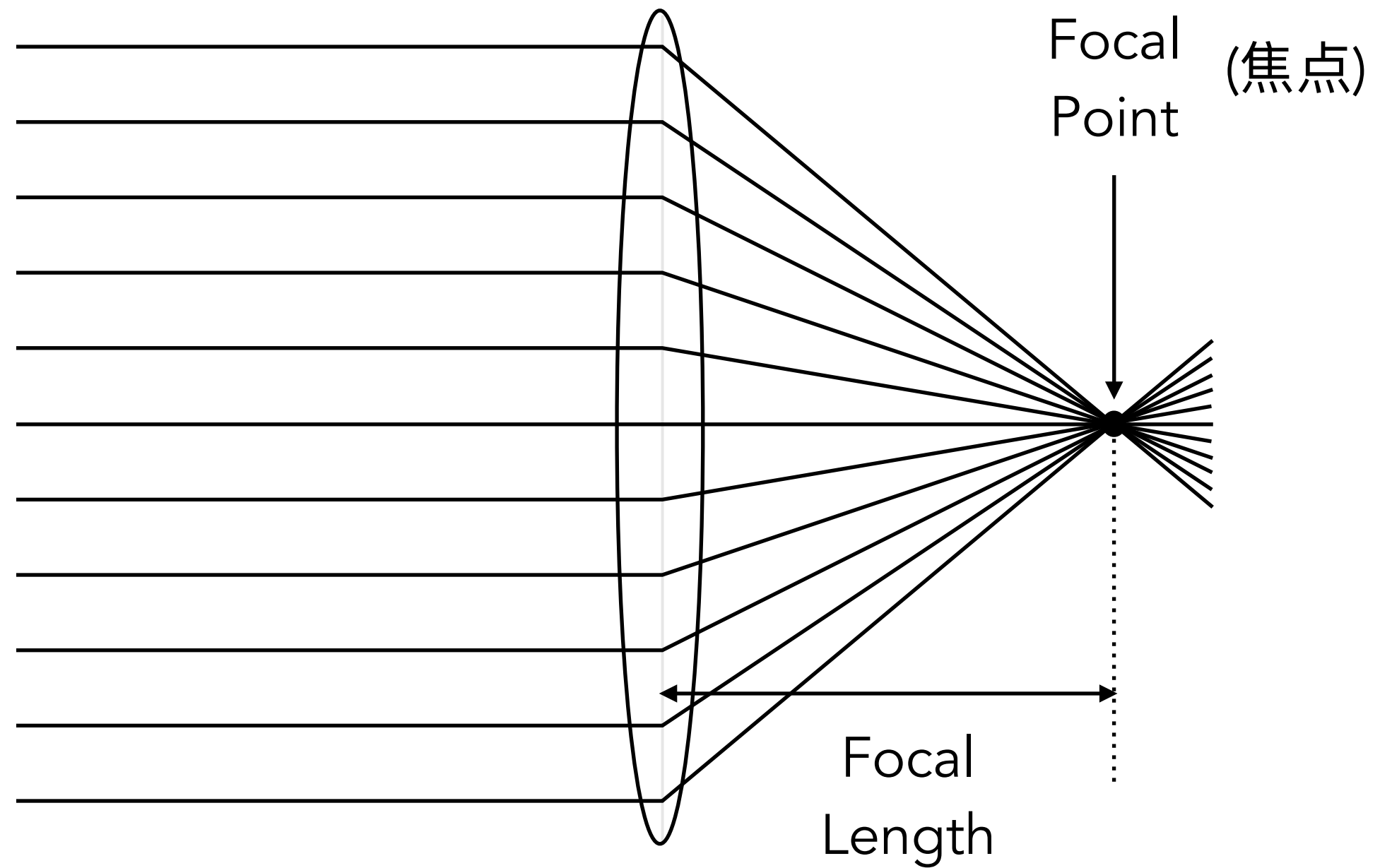

- (1) All parallel rays entering a lens pass through its focal point.
- (2) All rays through a focal point will be in parallel after passing the lens.
- (3) Focal length can be arbitrarily changed (in reality, yes!).

The Thin Lens Equation

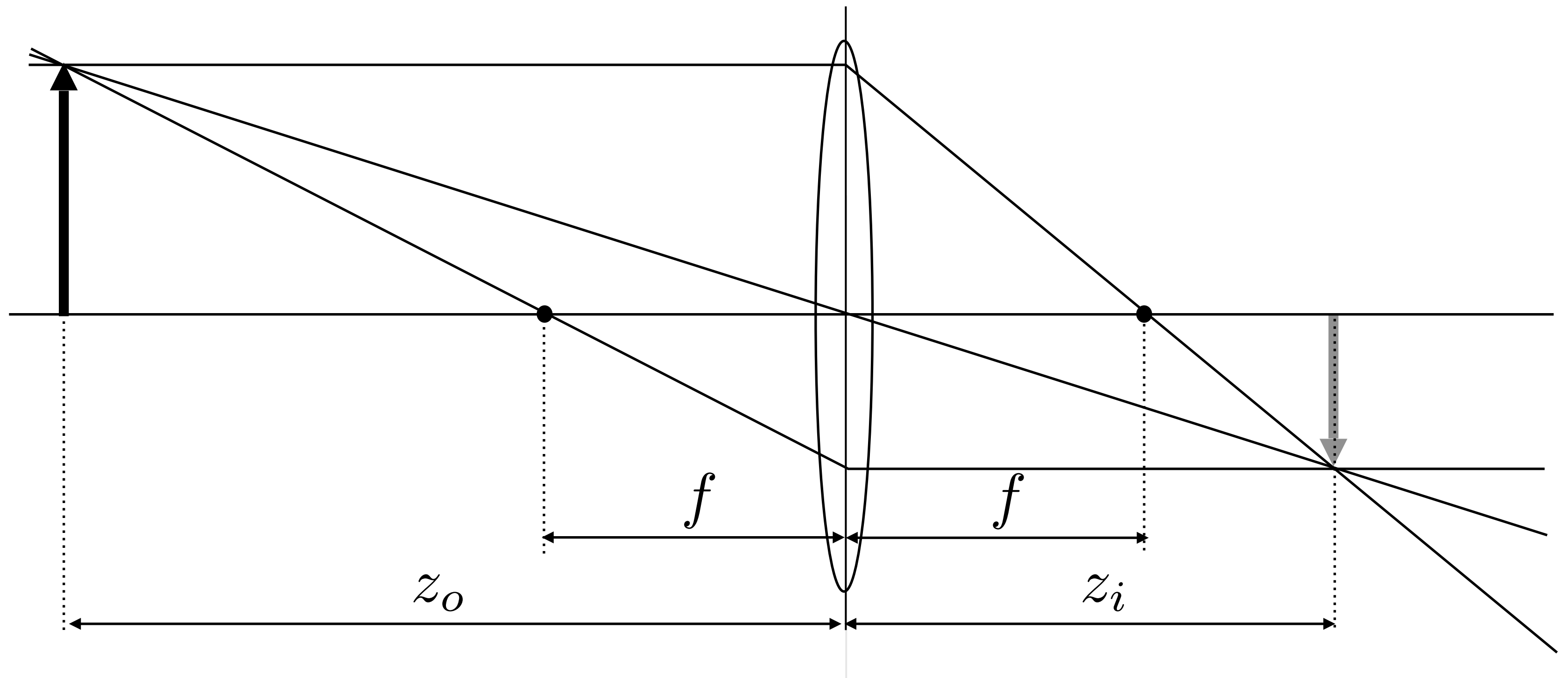

$$\frac{1}{f} = \frac{1}{z_i} + \frac{1}{z_o}$$

Gauss' Ray Diagrams

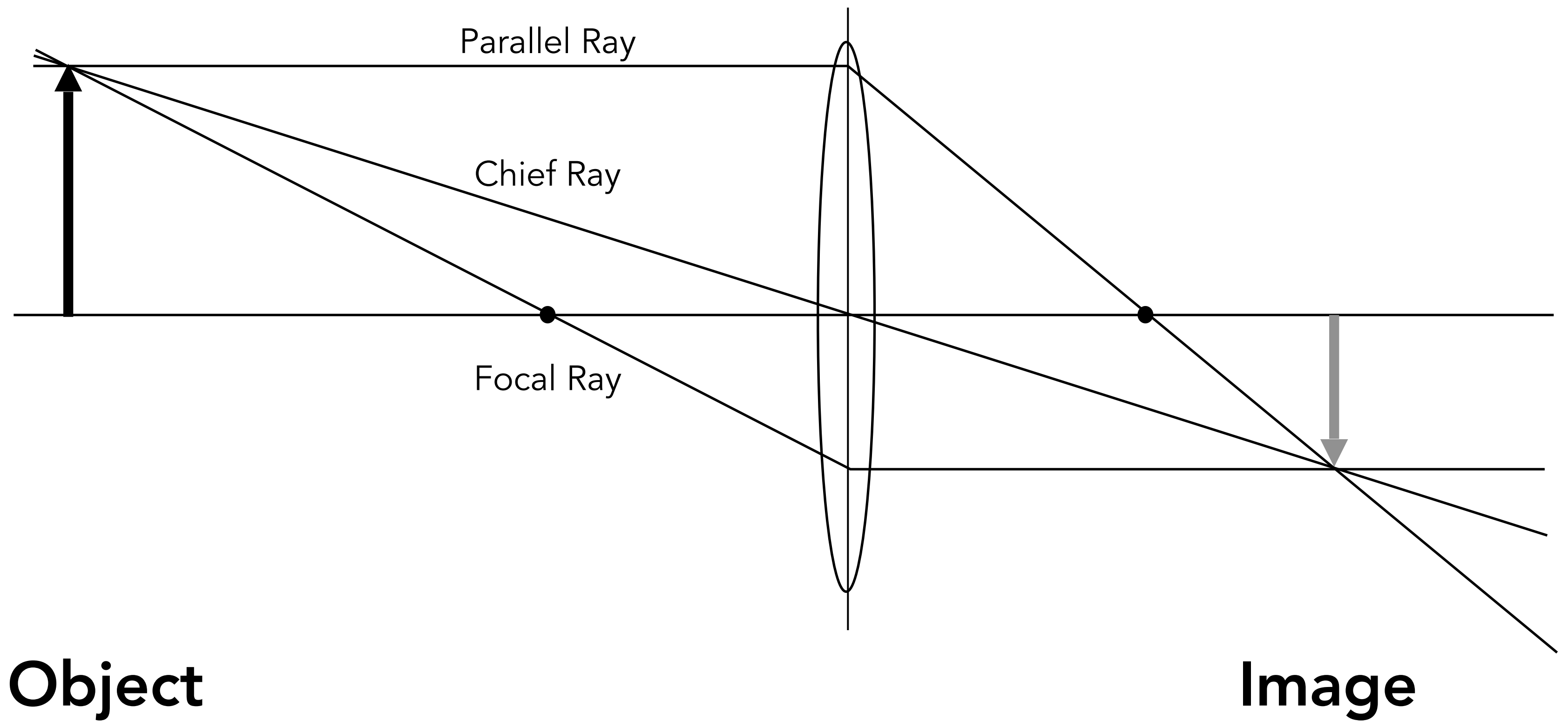

Gauss' Ray Tracing Construction

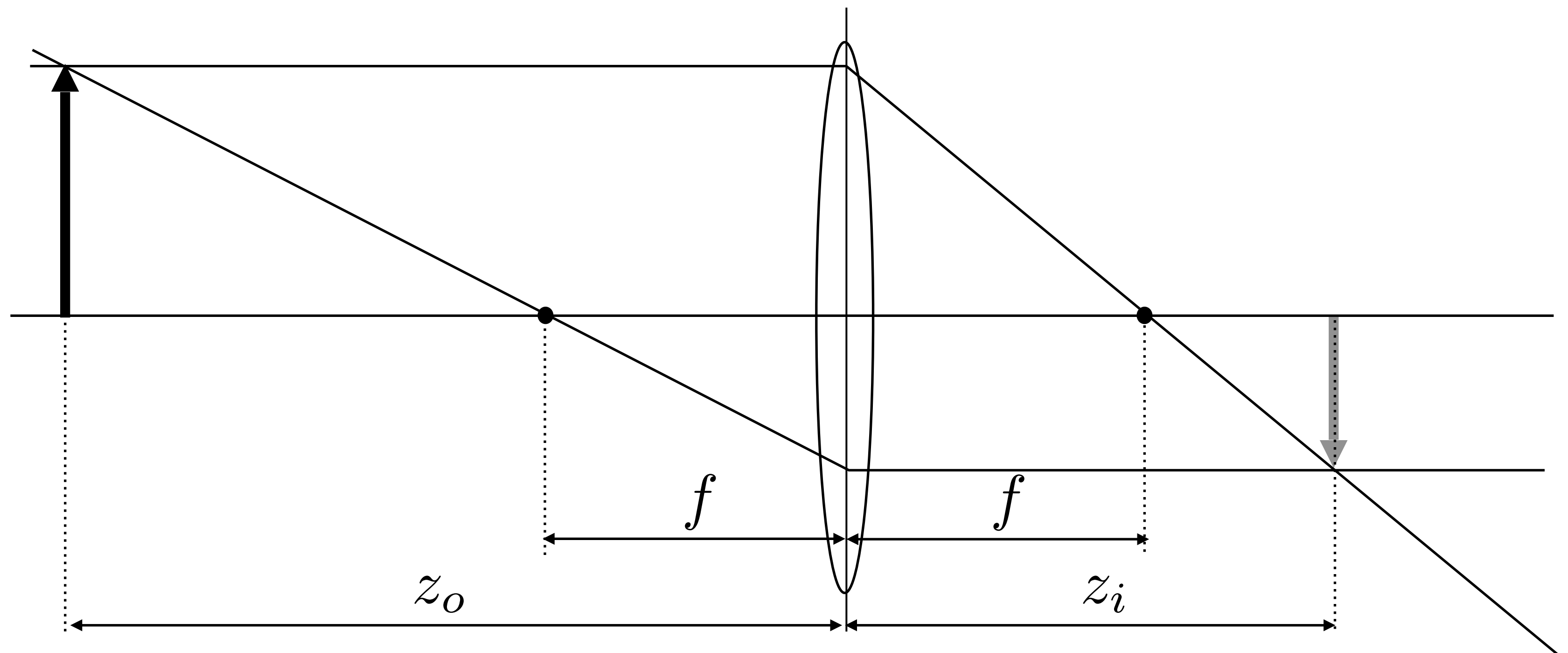

What is the relationship between conjugate depths z_o, z_i ?

Gauss' Ray Tracing Construction

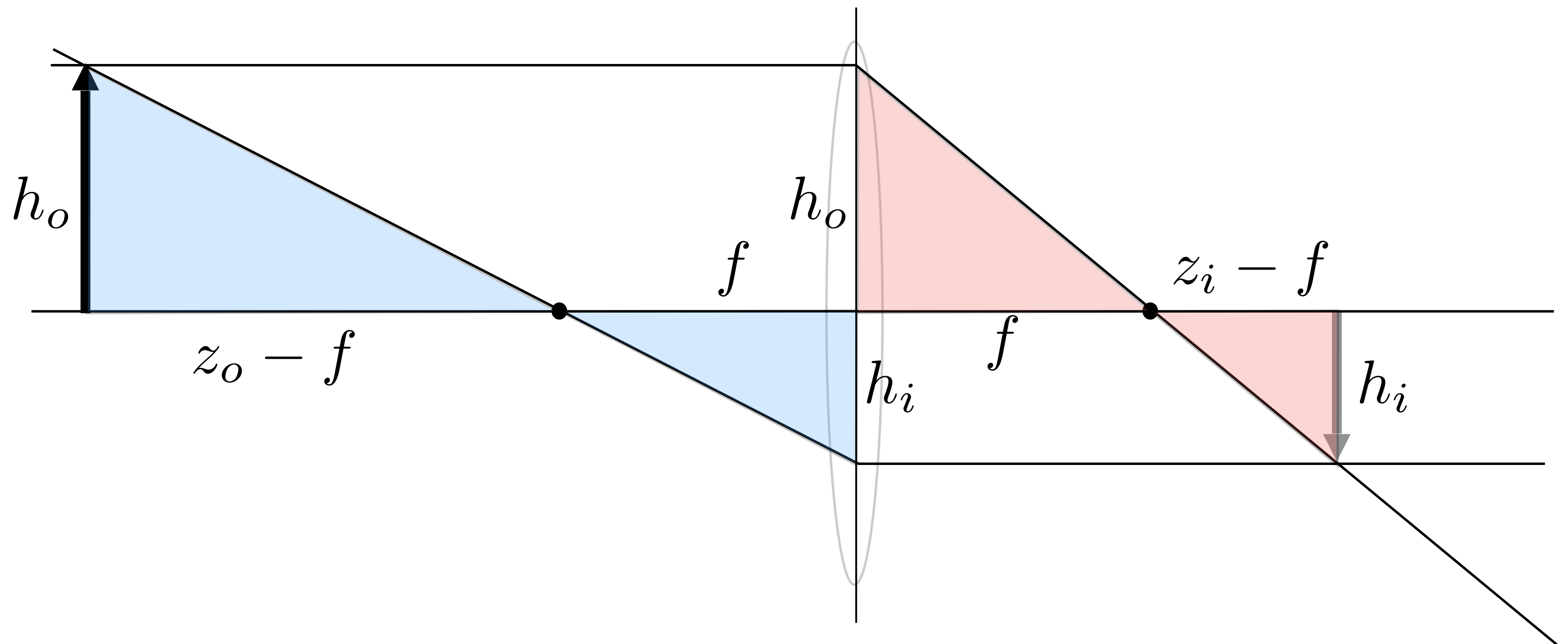

$$\frac{h_o}{z_o - f} = \frac{h_i}{f}$$

$$\frac{h_o}{f} = \frac{h_i}{z_i - f}$$

Gauss' Ray Tracing Construction

$$\frac{h_o}{z_o - f} = \frac{h_i}{f} \qquad \frac{h_o}{f} = \frac{h_i}{z_i - f}$$

$$\frac{h_o}{h_i} = \frac{z_o - f}{f} \qquad \frac{h_o}{h_i} = \frac{f}{z_i - f}$$

$$\frac{z_o - f}{f} = \frac{f}{z_i - f}$$

Object / image heights
factor out - applies to all rays

$$(z_o - f)(z_i - f) = f^2$$

Newtonian Thin Lens Equation

$$z_o z_i - (z_o + z_i)f + f^2 = f^2$$

$$z_o z_i = (z_o + z_i)f$$

$$\frac{1}{f} = \frac{1}{z_i} + \frac{1}{z_o}$$

Gaussian Thin Lens Equation

Thin Lens Demonstration

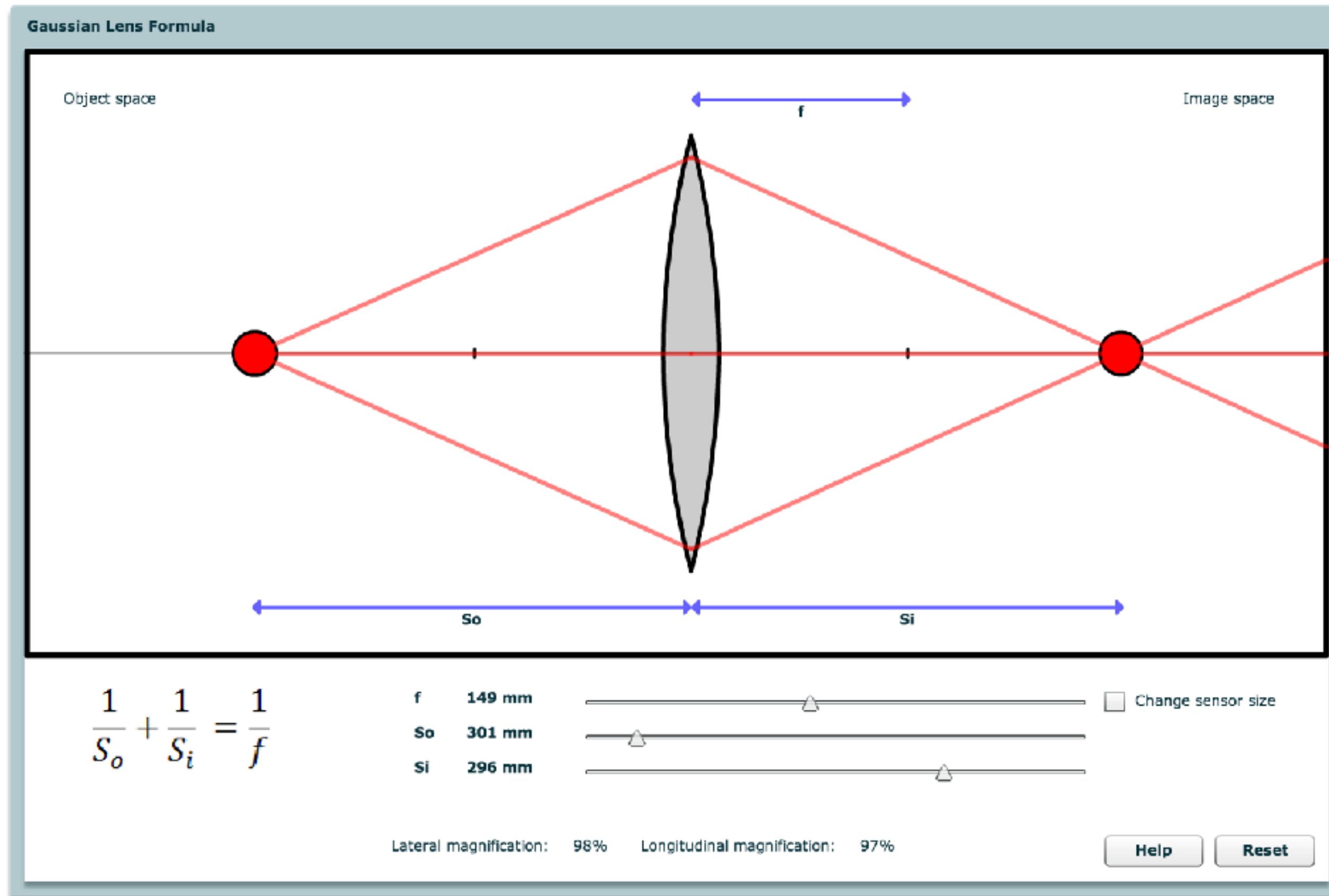

<http://graphics.stanford.edu/courses/cs178-10/applets/gaussian.html>

Defocus Blur

Computing Circle of Confusion (CoC) Size

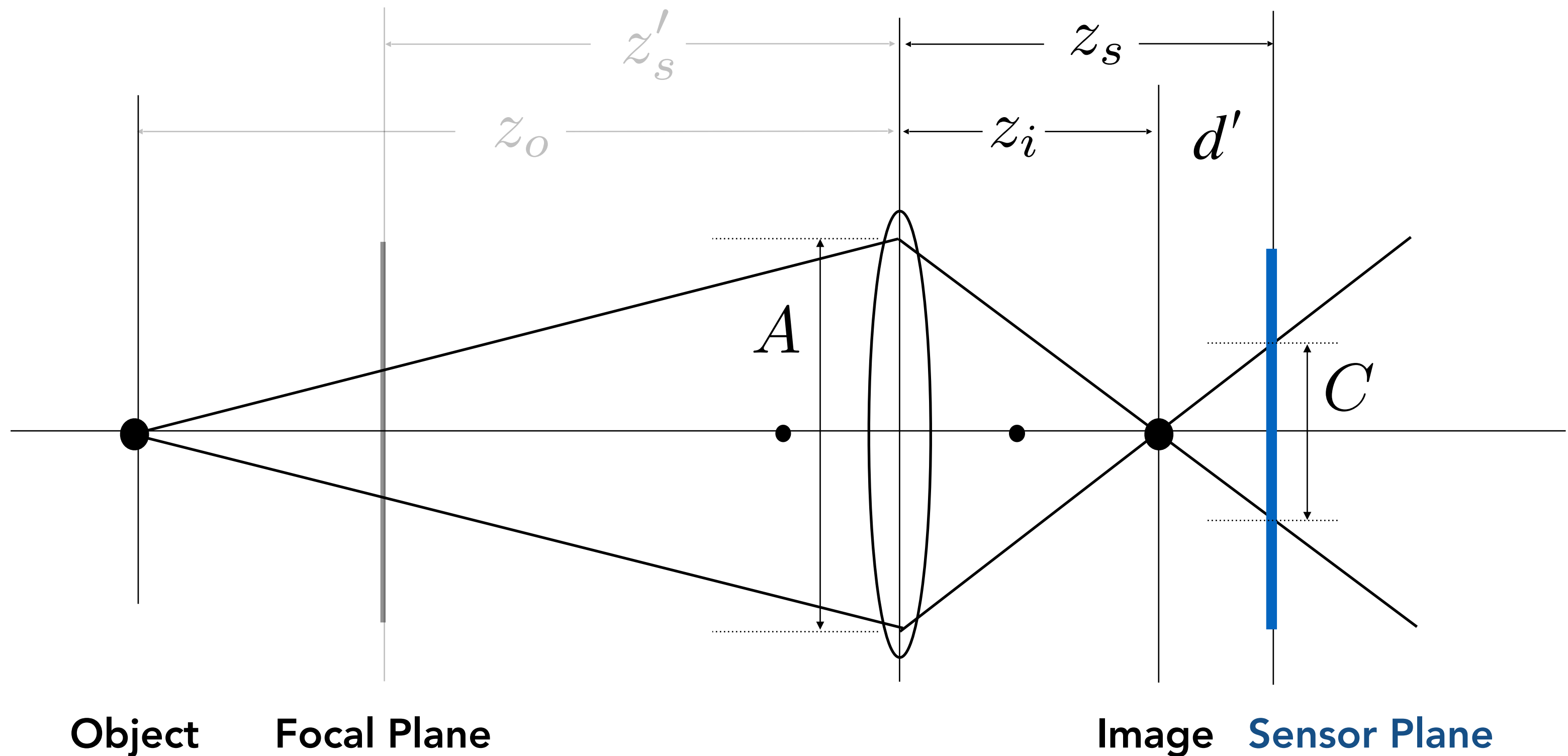

Circle of confusion is **proportional to the size of the aperture**

$$\frac{C}{A} = \frac{d'}{z_i} = \frac{|z_s - z_i|}{z_i}$$

CoC vs. Aperture Size

f/1.4



f/22



English - detected ↔ Chinese

circle of confusion	×	混乱的圈子 Hǔnlùn de quānzi
---------------------	---	---------------------------

Open in Google Translate Feedback

A side note: hilarious Google translate...

Revisiting F-Number (a.k.a. F-Stop)

- Formal definition: The f-number of a lens is defined as **the focal length divided by the diameter of the aperture**
- Common f-stops on real lenses:
1.4, 2, 2.8, 4.0, 5.6, 8, 11, 16, 22, 32
- An f-stop of 2 is sometimes written $f/2$, reflecting the fact that the absolute aperture diameter (A) can be computed by dividing focal length (f) by the relative aperture (N).

Example F-Stop Calculations

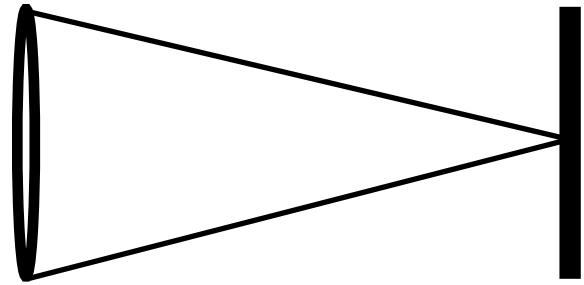

$$D = 50 \text{ mm}$$

$$f = 100 \text{ mm}$$

$$N = f/D = 2$$

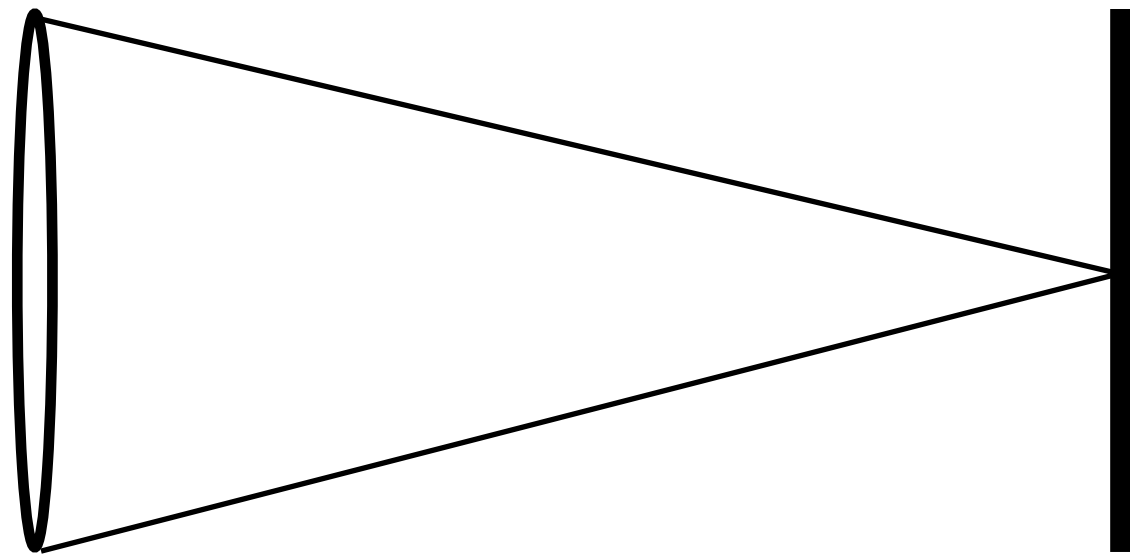

$$D = 100 \text{ mm}$$

$$f = 200 \text{ mm}$$

$$N = f/D = 2$$

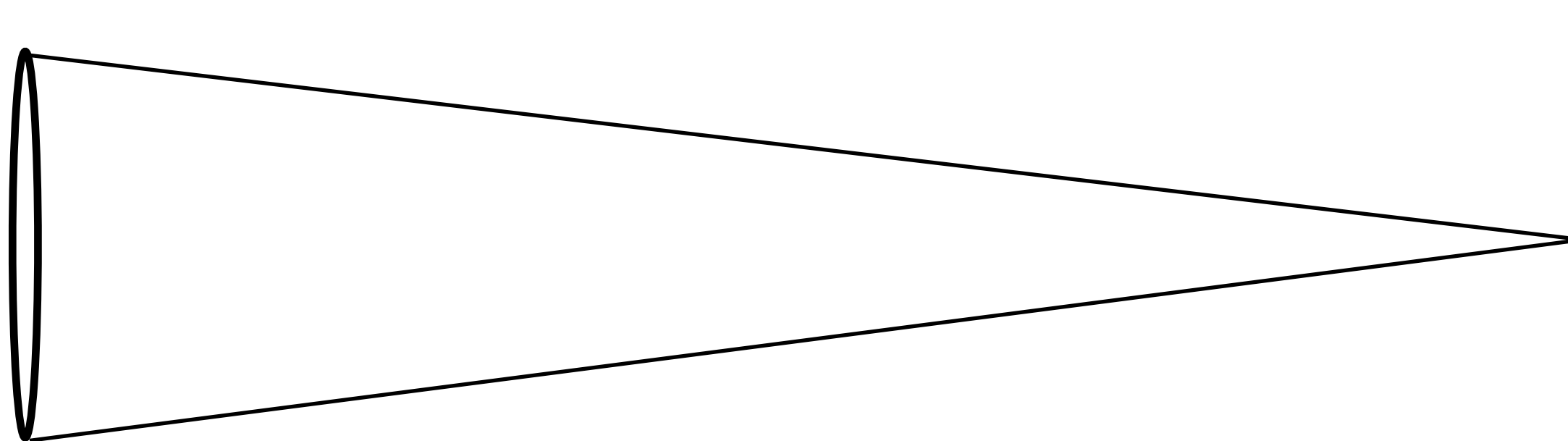

$$D = 100 \text{ mm}$$

$$f = 400 \text{ mm}$$

$$N = f/D = 4$$

Size of CoC is Inversely Proportional to F-Stop



R. Berdan, canadiannaturephotographer.com

$$C = A \frac{|z_s - z_i|}{z_i} = \frac{f}{N} \frac{|z_s - z_i|}{z_i}$$

Ray Tracing Ideal Thin Lenses

Examples of Renderings with Lens Focus



Pharr and Humphreys

Ray Tracing for Defocus Blur (Thin Lens)

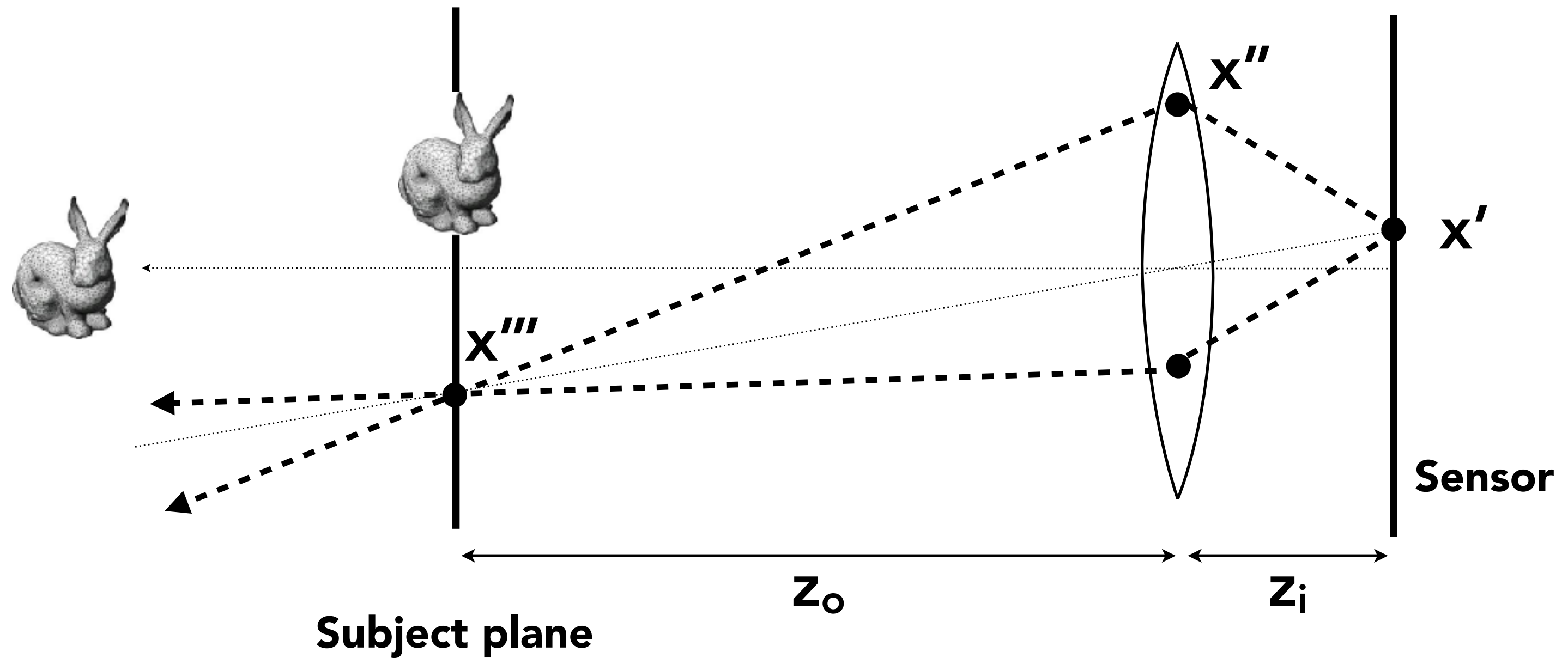

(One possible) Setup:

- Choose sensor size, lens focal length and aperture size
- Choose depth of subject of interest z_o
 - Calculate corresponding depth of sensor z_i from thin lens equation

Ray Tracing for Defocus Blur (Thin Lens)

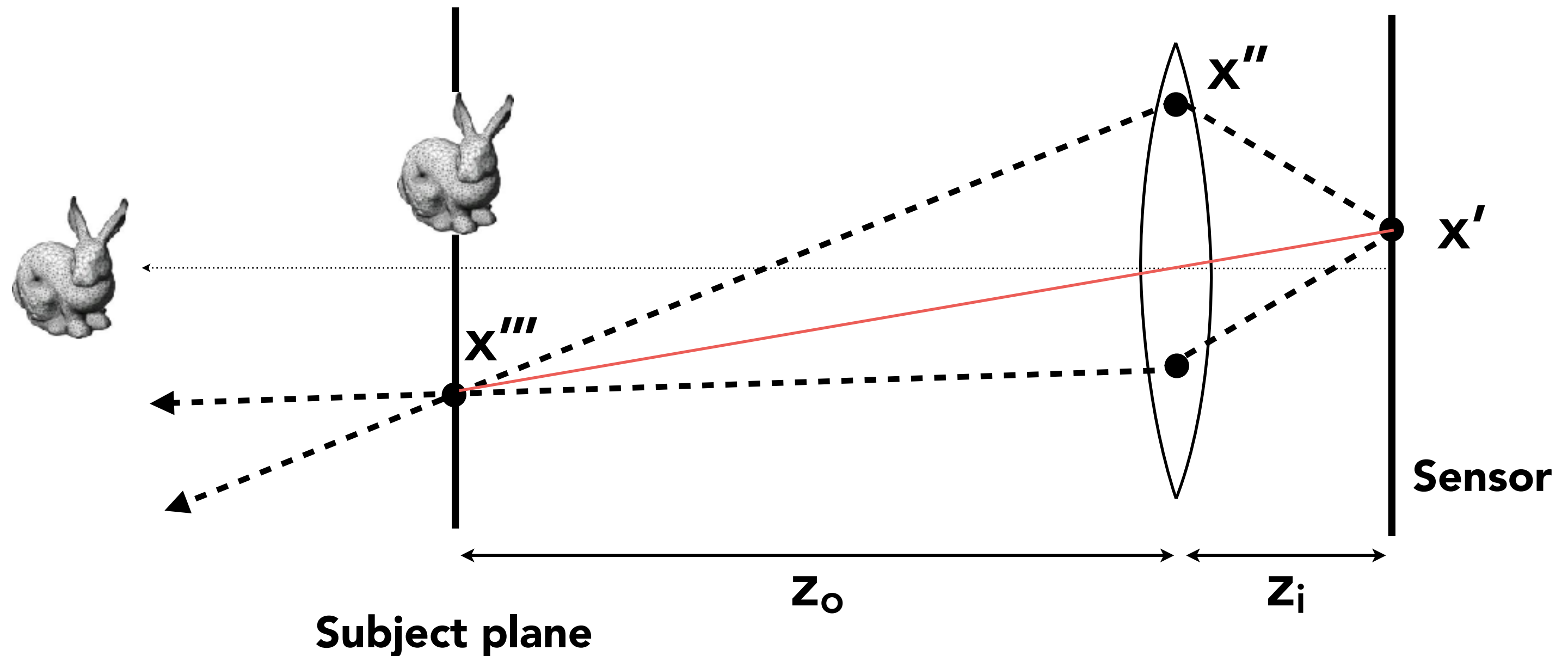

Rendering:

- For each pixel x' on the sensor (actually, film (胶片))
- Sample random points x'' on lens plane
- You know the ray passing through the lens will hit x'''
(because x''' is in focus, consider virtual ray (x' , center of the lens))
- Estimate radiance on ray $x'' \rightarrow x'''$

Depth of Field

Depth of Field

Large aperture opening



Small aperture opening



From London and Upton

Set circle of confusion as the maximum permissible blur spot on the image plane that will appear sharp under final viewing conditions

Circle of Confusion for Depth of Field

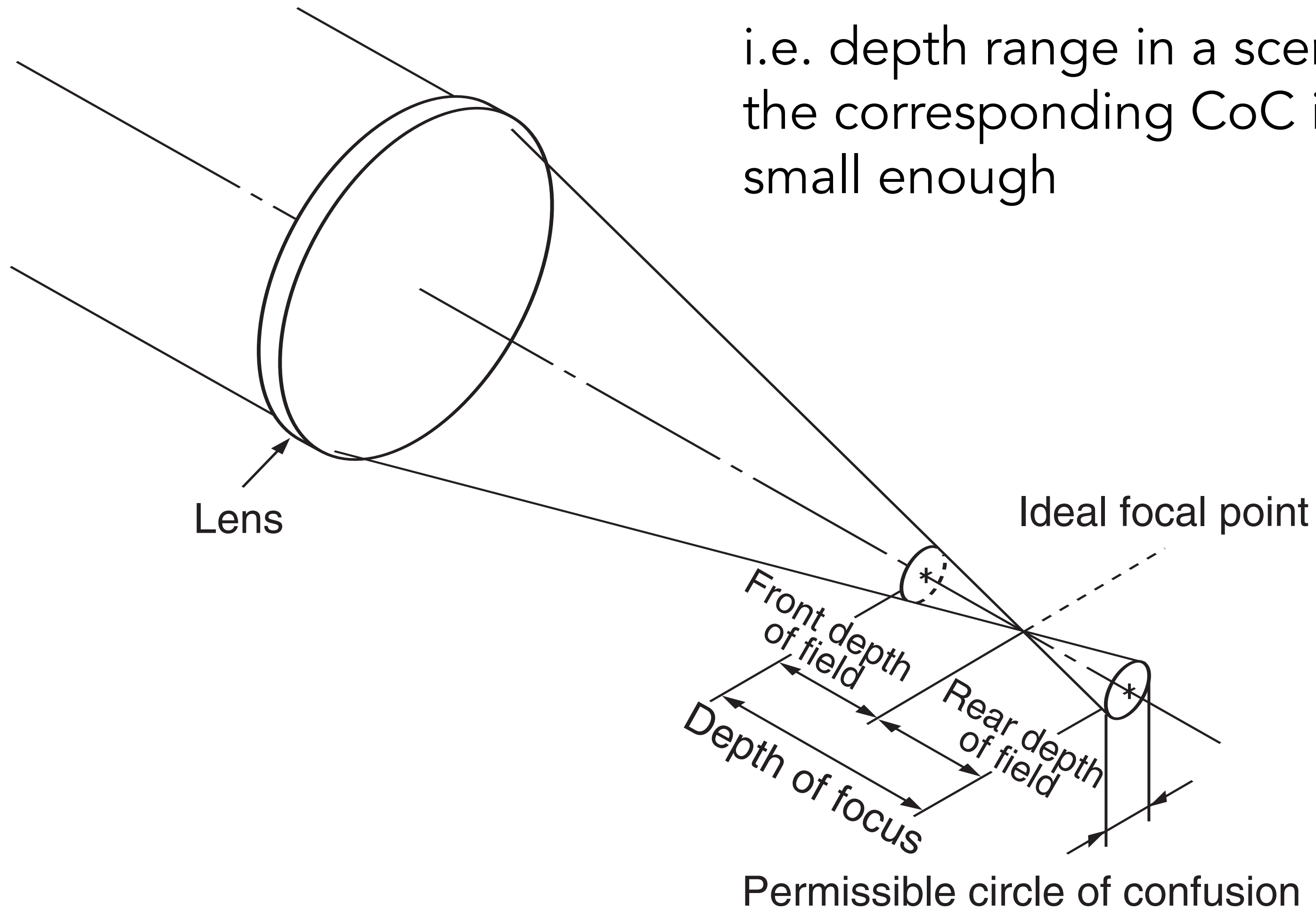

i.e. depth range in a scene where the corresponding CoC is considered small enough

[Canon, EF Lens Work III]

Depth of Field (FYI)

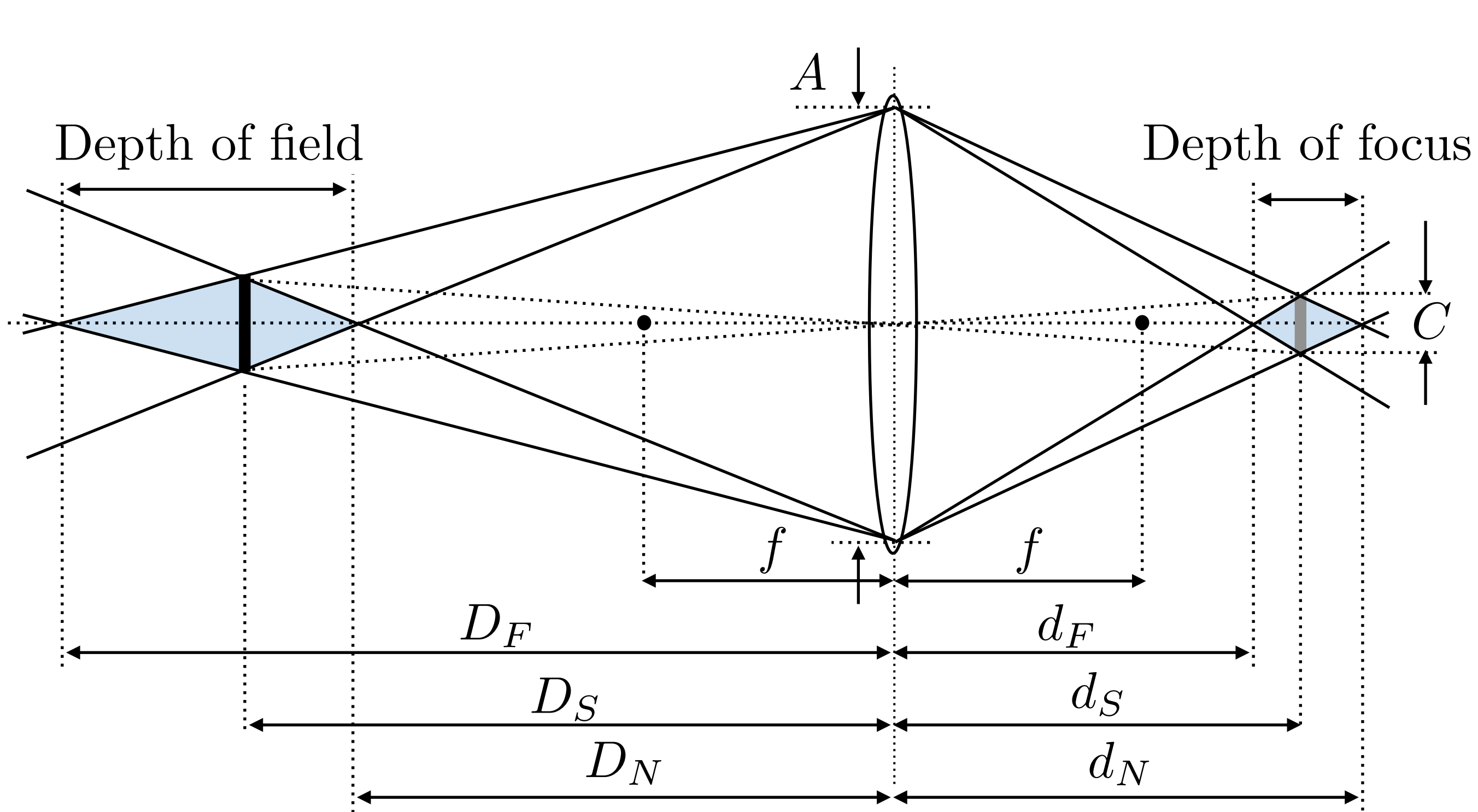

$$\frac{d_N - d_S}{d_N} = \frac{C}{A}$$

$$\frac{d_S - d_F}{d_F} = \frac{C}{A}$$

$$N = \frac{f}{A}$$

$$\frac{1}{D_F} + \frac{1}{d_F} = \frac{1}{f}$$

$$\frac{1}{D_S} + \frac{1}{d_S} = \frac{1}{f}$$

$$\frac{1}{D_N} + \frac{1}{d_N} = \frac{1}{f}$$

$$\text{DOF} = D_F - D_N$$

$$D_F = \frac{D_S f^2}{f^2 - NC(D_S - f)}$$

$$D_N = \frac{D_S f^2}{f^2 + NC(D_S - f)}$$

DOF Demonstration (FYI)

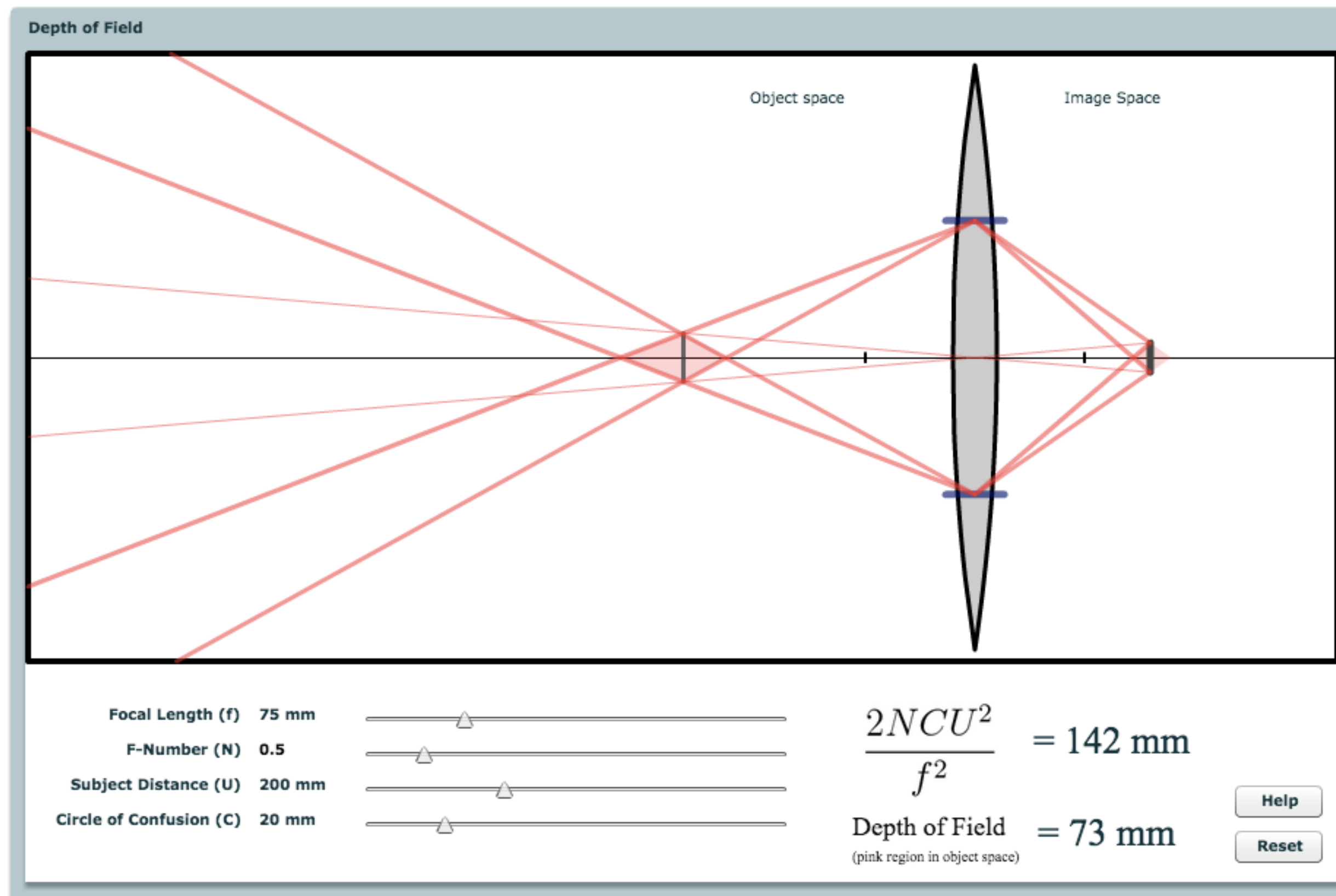

<http://graphics.stanford.edu/courses/cs178/applets/dof.html>

Thank you!

(And thank Prof. Ren Ng for many of the slides!)